

WALCHEM

An Iwaki America Company

WECT400/410 Controllers

WECT400/410 Series Cooling Tower Conductivity Controller Instruction Manual

Five Boynton Road Hopping Brook Park Holliston, MA 01746 USA

TEL: 508-429-1110 FAX: 508-429-7433 WEB: www.walchem.com

Notice

© 2009 WALCHEM, An Iwaki America Incorporated Company (hereinafter "Walchem")
5 Boynton Road, Holliston, MA 01746 USA
(508) 429-1110
All Rights Reserved
Printed in USA

Proprietary Material

The information and descriptions contained herein are the property of WALCHEM. Such information and descriptions may not be copied or reproduced by any means, or disseminated or distributed without the express prior written permission of WALCHEM, 5 Boynton Road, Holliston, MA 01746.

This document is for information purposes only and is subject to change without notice.

Statement of Limited Warranty

WALCHEM warrants equipment of its manufacture, and bearing its identification to be free from defects in workmanship and material for a period of 24 months for electronics and 12 months for mechanical parts and sensors from date of delivery from the factory or authorized distributor under normal use and service and otherwise when such equipment is used in accordance with instructions furnished by WALCHEM and for the purposes disclosed in writing at the time of purchase, if any. WALCHEM's liability under this warranty shall be limited to replacement or repair, F.O.B. Holliston, MA U.S.A. of any defective equipment or part which, having been returned to WALCHEM, transportation charges prepaid, has been inspected and determined by WALCHEM to be defective. Replaceable elastomeric parts and glass components are expendable and are not covered by any warranty.

THIS WARRANTY IS IN LIEU OF ANY OTHER WARRANTY, EITHER EXPRESS OR IMPLIED, AS TO DESCRIPTION, QUALITY, MERCHANTABILITY, FITNESS FOR ANY PARTICULAR PURPOSE OR USE, OR ANY OTHER MATTER.

180403.A1
Mar 2009

TABLE OF CONTENTS

1.0	INTRODUCTION.....	1
2.0	SPECIFICATIONS	2
2.1	Measurement Performance.....	2
2.2	Electrical: Input/Output.....	2
2.3	Mechanical.....	2
2.4	WECT Variables and their Limits	3
3.0	UNPACKING & INSTALLATION.....	4
3.1	Unpacking the unit	4
3.2	Mounting the electronic enclosure	4
3.3	Installation	4
3.4	Icon Definitions.....	4
3.5	Electrical installation.....	8
4.0	FUNCTION OVERVIEW	12
4.1	Front Panel.....	12
4.2	Display	12
4.3	Keypad	13
4.4	Access Code	13
4.5	Startup.....	13
4.6	Shut Down.....	14
5.0	OPERATION.....	14
5.1	Main Menu	14
5.2	Conductivity Menu.....	16
5.3	Temperature Menu.....	18
5.4	Bleed Menu	19
5.5	Feed Menu	21
5.6	Totalizer Menu	24
5.7	Bio1 and Bio2 Menus	25
5.8	Time Menu	29
5.9	Conductivity Alarm Menu	30
5.10	4-20mA Menu.....	31
5.11	Access Code Menu	32
5.12	Datalog Menu.....	33
5.13	Config Menu.....	34
5.14	Upgrade Menu	35
6.0	MAINTENANCE	36
6.1	Sensor Cleaning.....	36
6.2	Replacing the Fuses	36
7.0	TROUBLESHOOTING	37
7.1	Error Messages.....	37
7.2	Conductivity Readout Does Not Change	38
7.3	Procedure for Evaluation of Conductivity Sensor.....	38
8.0	SERVICE POLICY	39

1.0 INTRODUCTION

The Walchem WECT400 Series controllers offer conductivity control of cooling tower water, control of corrosion/scale inhibitor feed, and with the WECT410 models, control of two biocide pumps. The inhibitor pump may be selected to operate in one of the following modes:

- Feed and Bleed
- Feed and Bleed with Lockout
- Feed as a percent of Bleed
- Feed as a percent of Time
- Feed based on a Water Contactor input
- Feed based on a Paddlewheel water meter input

The WECT series cooling tower controllers are supplied with a temperature compensated electrodeless conductivity sensor. The controllers are microprocessor driven industrial type with on/off control outputs. A timed sample mode may be selected, and on small towers can reduce installation costs by eliminating the need for a sampling bypass line. An optional isolated 4-20 mA output that is proportional to the conductivity reading is available for all models.

Any set point may be viewed without interrupting control. Each set point change will take effect as soon as it is entered. An access code is available to protect set point parameters, while still allowing settings to be viewed.

The model WECT410 biocide outputs are scheduled on a user selectable 1, 2, or 4 week cycle. Each biocide output is independent and may be programmed for one add per day. (in 1, 2 or 4 week cycle) or up to 10 times per day (in daily cycle). It is possible to add both chemicals in the same day, however, as a safeguard they will not occur at the same time. Biocide outputs may use independent pre-bleeds and lockout times. All outputs are interlocked with a flow switch input.

An alarm relay is provided with WECT410 models. It is triggered by:

- Low Conductivity reading
- High Conductivity reading
- No Flow situation
- Bleed Timeout
- Sensor Error
- Temp Error

Our unique USB feature provides the ability to upgrade the software in the controller to the latest version.

An advanced USB capability option is available. The Config file feature allows you to save all the set points from a controller onto a USB flash disk, and then import them into another controller, making the programming of multiple controllers fast and easy. The data logging feature allows you to save the last 2 month's readings and events to a USB flash disk.

2.0 SPECIFICATIONS

2.1 Measurement Performance

Conductivity Range	1,0000 - 10,000 μ S/cm (microSiemens/centimeter) 50-1,000 μ S/cm
Conductivity Resolution	1 μ S/cm
Conductivity Accuracy	Within range \pm 1% of reading Outside range \pm 20% of reading
Temperature Range	32 - 158°F (0 - 70°C)
Temperature Resolution	\pm 1°F (1°C)
Temperature Accuracy	\pm 1°F (1°C)

2.2 Electrical: Input/Output

Input Power	100-240 VAC, 50/60 Hz, 8A Fuse: 1.0 ampere, 5 x 20 mm
Input Signals	
Conductivity sensor	\pm 2000 mV, 10K thermistor
Flow Meter (optional)	Isolated, dry contact closure required (i.e. relay, reed switch)
Flow Switch (optional)	Isolated, dry contact closure required (i.e. reed switch)
Outputs	
Mechanical Relays	Pre-powered on circuit board switching line voltage 6 A (resistive), 1/8 HP All relays are fused together as one group, total current for this group must not exceed 6A
4 - 20 mA (optional)	Internally powered Fully isolated 600 Ohm max resistive load Resolution .001% of span Accuracy \pm 1% of reading
Agency Approvals	
UL	ANSI/UL 61010-1:2004, 2 nd Edition*
CAN/CSA	C22,2 No.61010-1:2004 2 nd Edition*
CE Safety	EN 61010-1 2 nd Edition (2001)*
CE EMC	EN 61326 :1998 Annex A*

Note: For EN61000-4-6,-3 the controller met performance criteria B.

*Class A equipment: Equipment suitable for use in establishments other than domestic, and those directly connected to a low voltage (100-240 VAC) power supply network which supplies buildings used for domestic purposes.

2.3 Mechanical

Enclosure Material	Polycarbonate
NEMA Rating	NEMA 4X
Dimensions	8.5" x 6.5" x 5.5"
Display	2 x 16 character backlit liquid crystal
Operating Ambient Temp	32 – 122°F (0 – 50°C)
Storage Temperature	-20 – 180°F (-29 – 80°C)
Conductivity sensor pressure rating	0 to 140 psi (0 to 1 MPa)
Sensor materials of construction	CPVC, FKM
Submersion sensor mounting	1" NPTM
Flow switch manifold pressure rating	0-140 psi (0 – 1 MPa)
Flow switch manifold materials	CPVC, PVC, FKM, Isoplast, PP
Flow switch/in-line connections	3/4" NPTF

2.4 WECT Variables and their Limits

		Low Limit	High Limit
Conductivity menu			
	PPM Conversion Factor	0.200 ppm/ μ S/cm	1.000 ppm/ μ S/cm
	Days Between Calibration	0 days (no reminder)	59 days
	Interval Time (sampling)	5 minutes	24:00 hours
	Duration Time (sampling)	1 minute	59 min: 59 sec
	% Calibration Range	-50	+50
	Damping	12 seconds	48 seconds
Temperature Menu			
		No variables	
Bleed Menu			
	Set Point	0 μ S/cm	10,000 μ S/cm
	Dead Band	5 μ S/cm	500 μ S/cm
	Bleed Limit Time (set in hours/minutes)	1 minute	8 hrs: 20 min (enabled) 0=unlimited (disabled)
Feed Menu			
	Feed Lockout Timer (Mode A)	1 second	99 min: 59 sec
	Percent of Bleed (Mode B)	5 %	99 %
	Feed Time Limit (Mode B)	1 minute	99 min: 59 sec
	Percent of Time (Mode C)	0.1 %	99 %
	Feed Cycle Time (Mode C)	10 minutes	59 min: 59 sec
	Time per Contact (Mode D)	1 second	59 min: 59 sec
	÷ Contacts by (Mode D)	1 contact	100 contacts
	Time Limit (Mode D & E)	1 minute	99 min: 59 sec
	Time/Vol (Mode E)	1 second	59 min: 59 sec
	Vol to Initiate Feed (Mode E)	1	9,999
	K Factor (Mode E)	0.01 pulse/vol	999.99 pulses/vol
Totalizer Menu (WECT410 only)			
	Gallons per Contact	1 gal/contact	500 gal/contact
	Liters per Contact	1 L/contact	500 L/contact
Biocide Menus (WECT410 only)			
	Pre-Bleed (0 disables pre-bleed)	1 μ S/cm	9.999 μ S/cm
	Lockout	0 minutes	9 hrs:59 min
	Add Time		
	Daily Adds	0 minutes	144 minutes
	All other modes	0 minutes	1440 minutes
4-20 mA Menu			
	4 & 20 mA Settings	0 μ S/cm	10,000 μ S/cm
Access Code Menu			
	New Value	0	9999
Alarm Menu*			
	High & Low (set to zero to disable)	1%	50%
Datalog Menu (Optional)			
		No variables	
Config Menu (Optional)			
		No variables	
Upgrade Menu			
		No variables	

*Note: The Alarm relay is non-programmable. Refer to the Main Menu diagram on page 16 for the list of error conditions that trigger the alarm relay.

3.0 UNPACKING & INSTALLATION

3.1 Unpacking the unit

Inspect the contents of the carton. Please notify the carrier immediately if there are any signs of damage to the controller or its parts. Contact your distributor if any of the parts are missing. The carton should contain: a WECT400 series controller and instruction manual. Any options or accessories will be incorporated as ordered.

3.2 Mounting the electronic enclosure

The WECT series controller is supplied with mounting holes on the enclosure. It should be wall mounted with the display at eye level, on a vibration-free surface, utilizing all four mounting holes for maximum stability. Use M6 (1/4" diameter) fasteners that are appropriate for the substrate material of the wall. The enclosure is NEMA 4X rated. The maximum operating ambient temperature is 122°F (50°C); this should be considered if installation is in a high temperature location. The enclosure requires the following clearances:

Top:	2" (50 mm)
Left:	8" (203 mm)
Right:	4" (102 mm)
Bottom:	7" (178 mm)

3.3 Installation





Once the WECT series controller is mounted, the metering pumps may be located at any distance from the controller. The conductivity sensor should be placed as close to the controller as possible, to a maximum distance of 250 ft. Less than 20 ft is recommended. The cable must be shielded from background electrical noise.

Always route low voltage (sensor) signals with at least a 6" separation from AC voltage wiring.

Locate the sensor tee where an active sample of cooling tower water is available and where the sensor can easily be removed for cleaning. It must be situated so that the tee is always full and the sensor is never subjected to a drop in water level resulting in dryness. Refer to Figure 1 for typical installation.

IMPORTANT: To avoid cracking the female pipe threads on the supplied plumbing parts, use no more than 3 wraps of Teflon tape and thread in the pipe FINGER tight plus 1/2 turn! ***Do not use pipe dope to seal the threads of the flow switch because the clear plastic will crack!***

3.4 Icon Definitions

Symbol	Publication	Description
	IEC 417, No.5019	Protective Conductor Terminal
	IEC 417, No. 5007	On (Supply)
	IEC 417, No. 5008	Off (Supply)
	ISO 3864, No. B.3.6	Caution, risk of electric shock
	ISO 3864, No. B.3.1	Caution

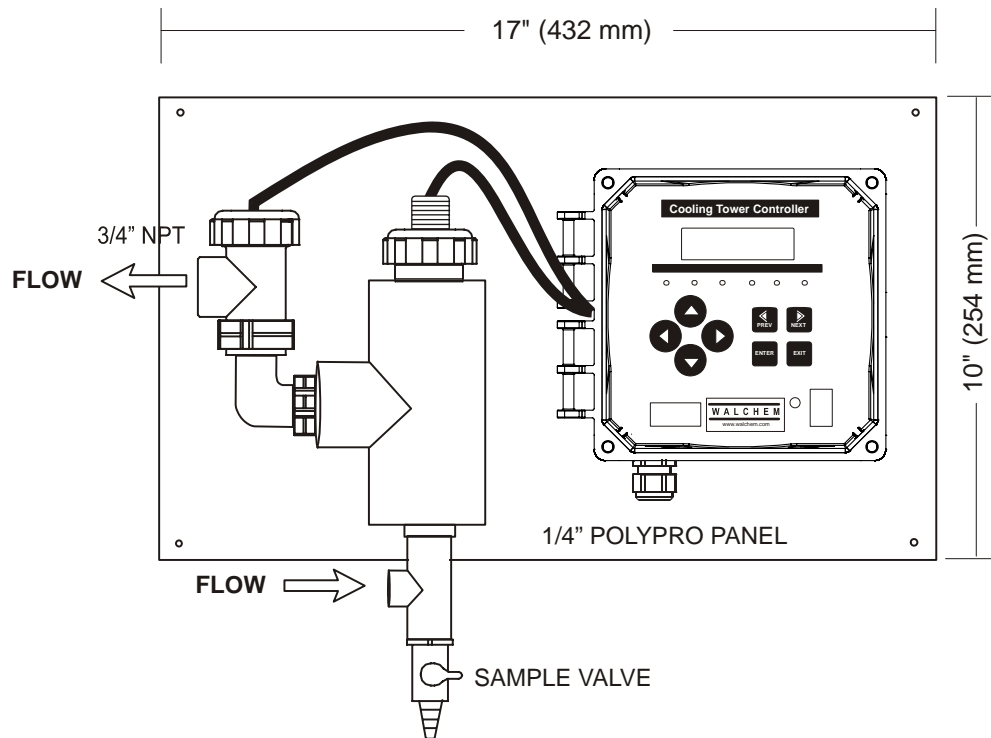
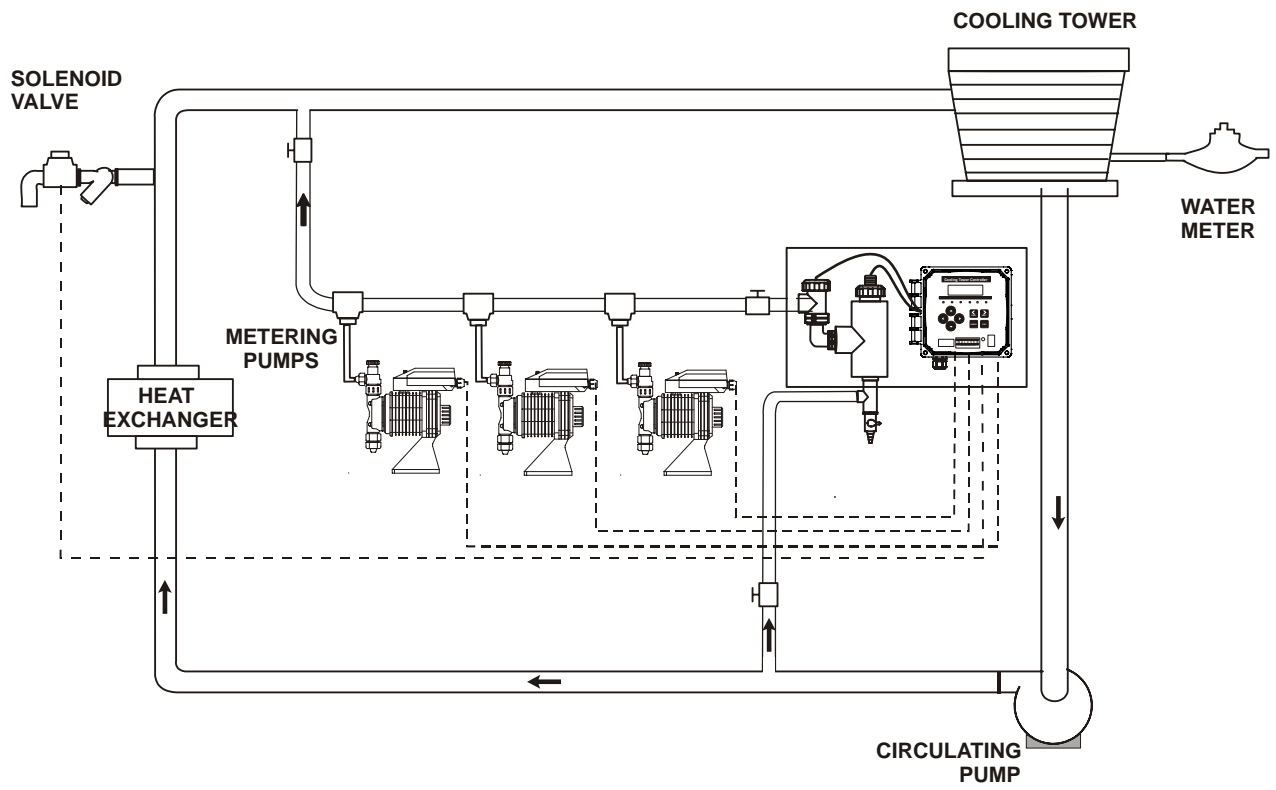
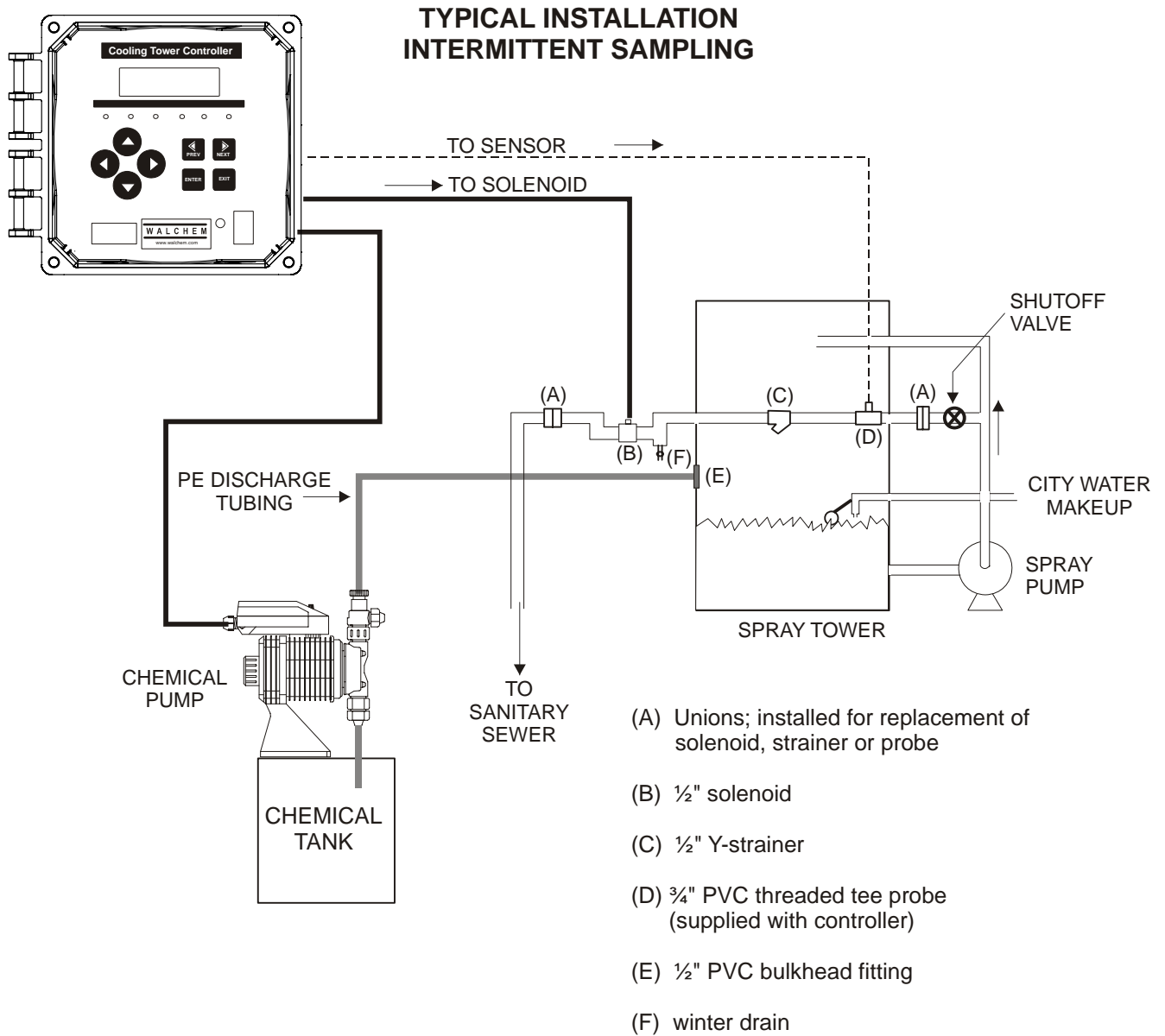
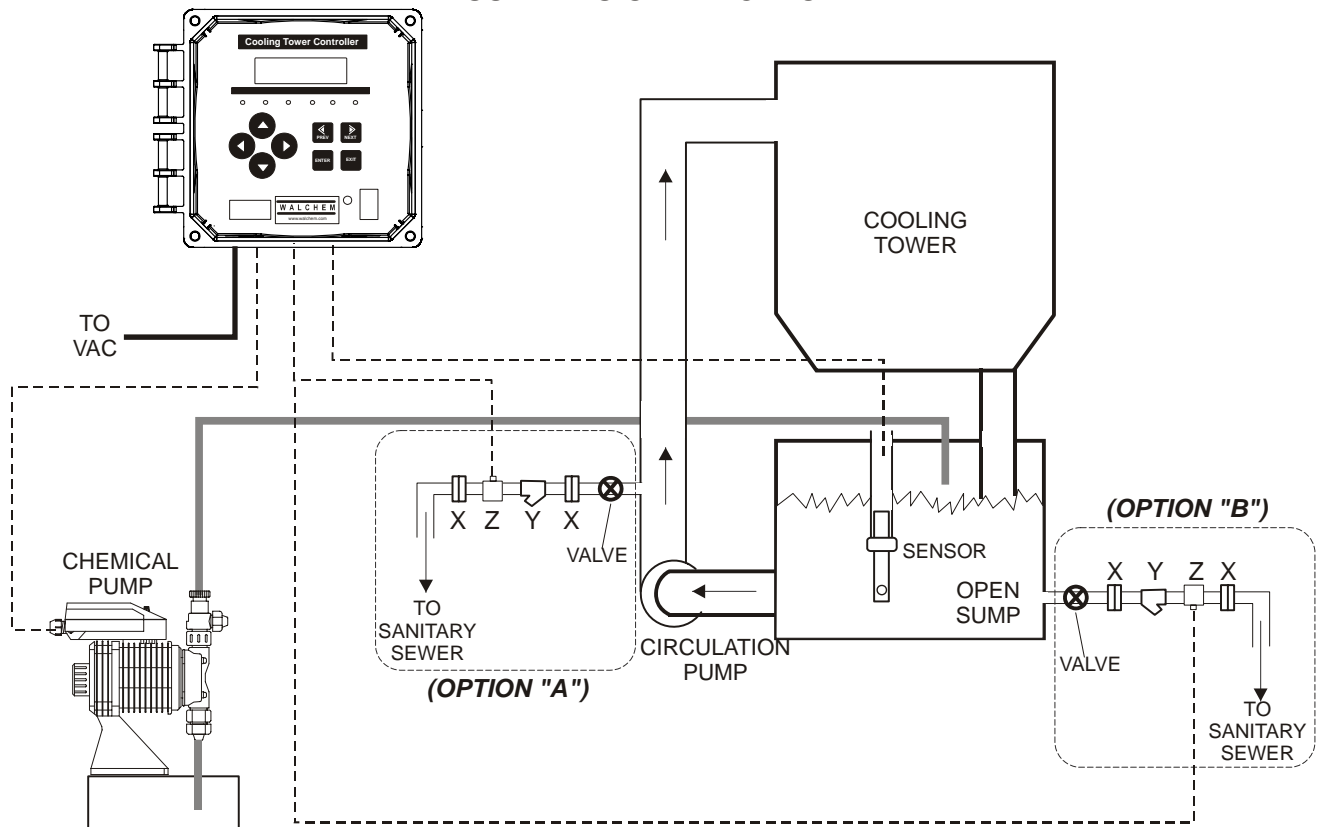

Figure 1 Typical Installation



**Figure 1a Typical Installation
Intermittent Sampling**

TYPICAL INSTALLATION SUBMERSION ELECTRODE



- (X) Unions; installed for replacement of solenoid or strainer
- (Y) 1/2" Y-strainer
- (Z) 1/2" solenoid

NOTE: LOCATION OF SOLENOID VALVE USING OPTION "A" OR OPTION "B" DEPENDS ON SYSTEM CONFIGURATION.

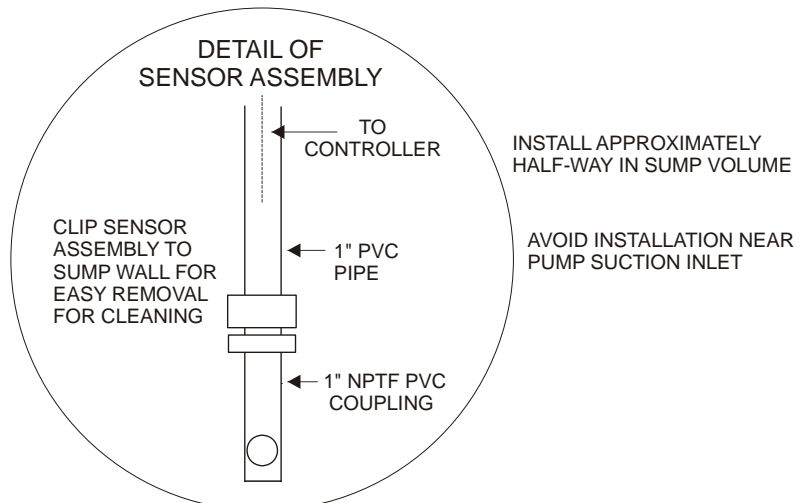

**Figure 1b Typical Installation
Submersion Sensor**

3.5 Electrical installation

The various standard wiring options are shown in figure 2. Your WECT series controller will arrive from the factory prewired or ready for hardwiring. Depending on your configuration of controller options, you may be required to hardwire some or all of the input/output devices. Refer to figures 3 and 4 for circuit board layout and wiring.

Note: when wiring the optional flow meter contactor input, the 4-20 mA output or a remote flow switch, it is advisable to use stranded, twisted, shield pair wire between 22-26 AWG. Shield should be terminated at the controller ground stud (see figures 3 and 4).



CAUTION



1. There are live circuits inside the controller even when the power switch on the front panel is in the OFF position! The front panel must never be opened before power to the controller is REMOVED!
If your controller is prewired, it is supplied with a 8 foot, 18 AWG power cord with USA style plug. A tool (#1 Phillips driver) is required to open the front panel.
2. When mounting the controller, make sure there is clear access to the disconnecting device!
3. The electrical installation of the controller must be done by trained personnel only and conform to all applicable National, State and Local codes!
4. Proper grounding of this product is required. Any attempt to bypass the grounding will compromise the safety of persons and property.
5. Operating this product in a manner not specified by Walchem may impair the protection provided by the equipment.

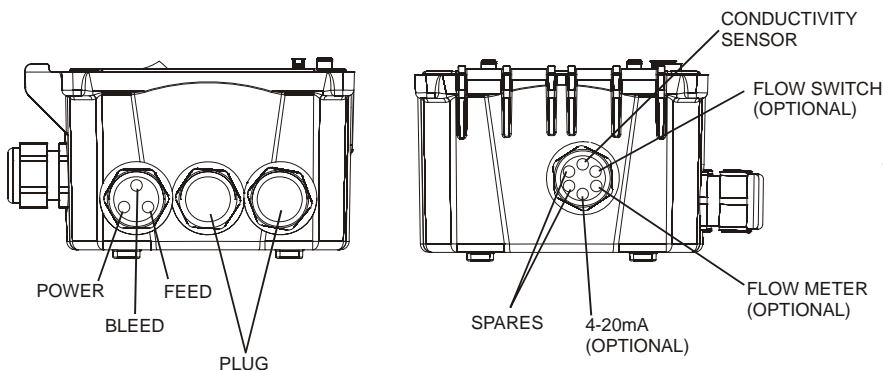

Figure 2a WECT400 Conduit Wiring

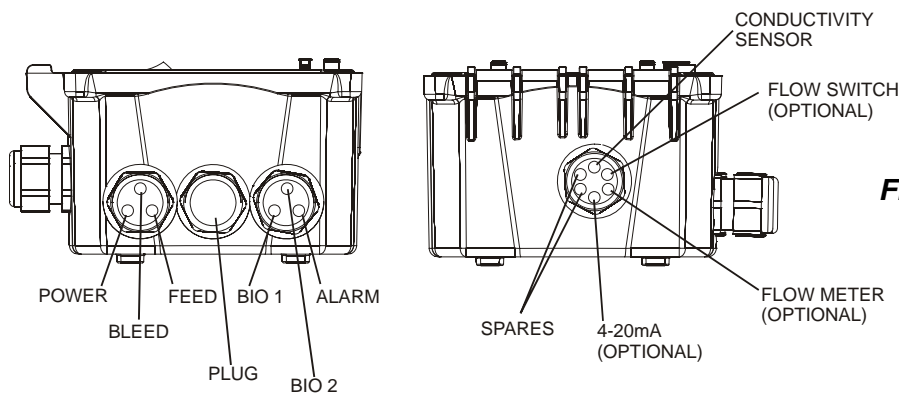

Figure 2b WECT410 Conduit Wiring

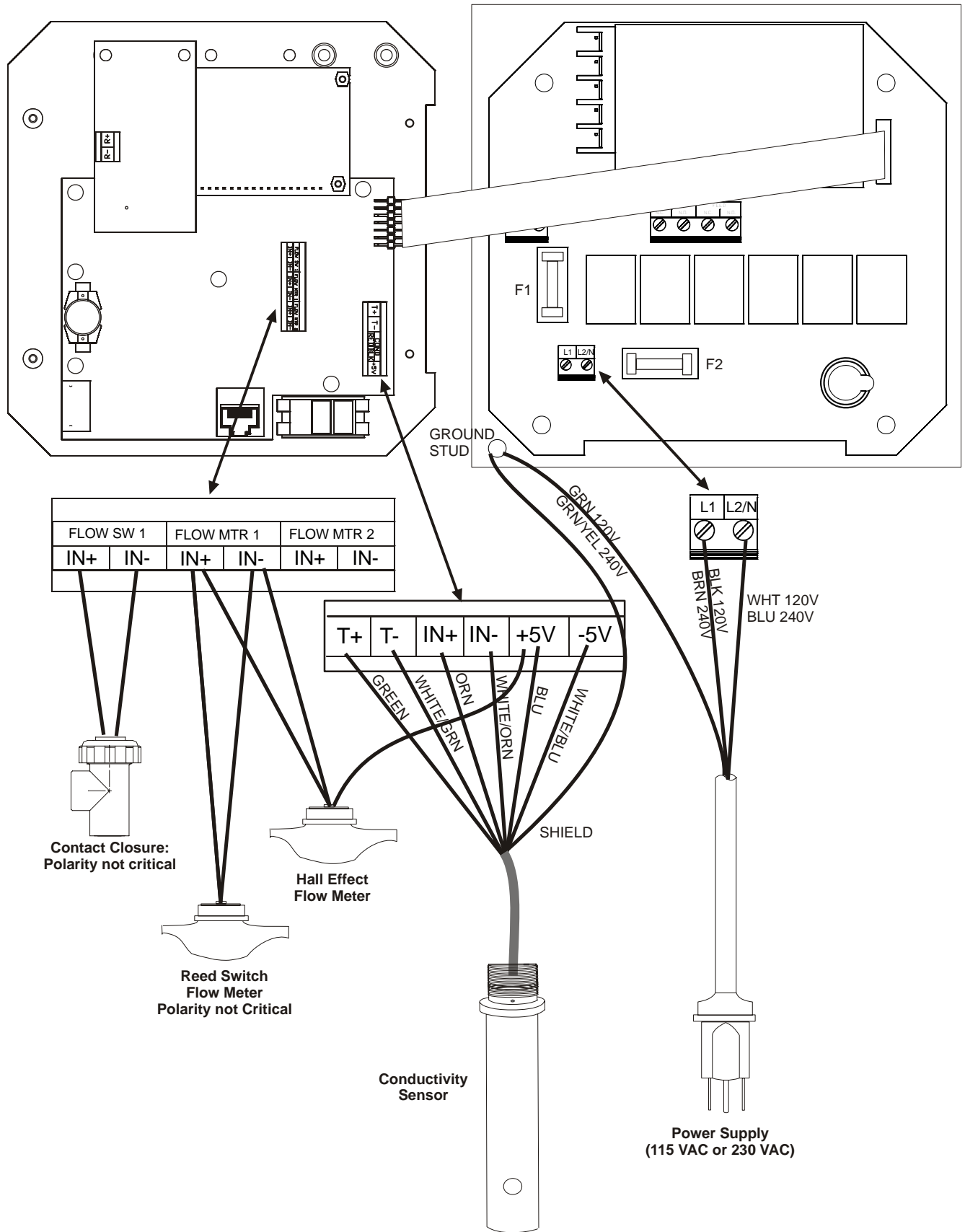

Figure 3 Inputs

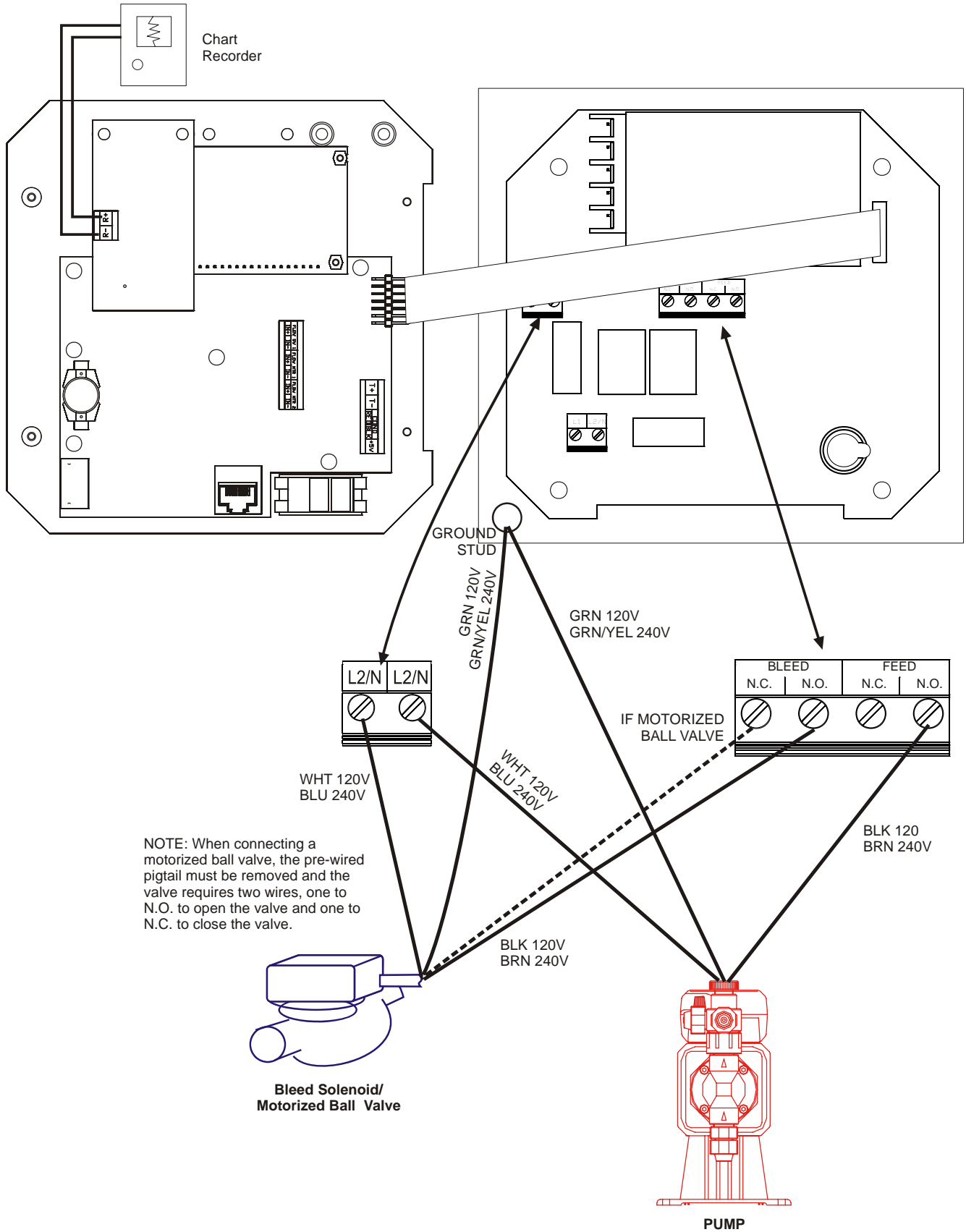

Figure 4a WECT400 Outputs

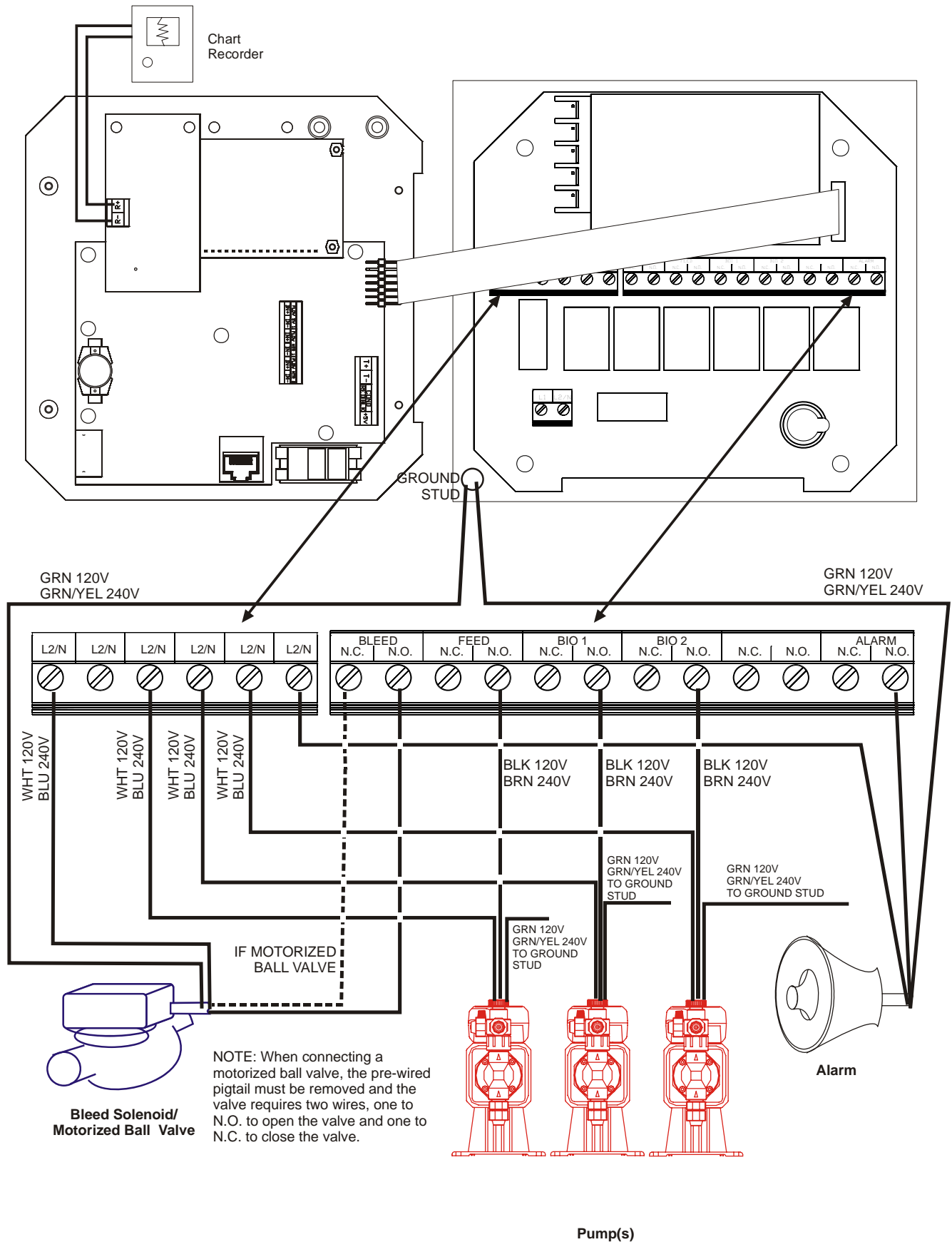

Figure 4b WECT410 Outputs

4.0 FUNCTION OVERVIEW

4.1 Front Panel

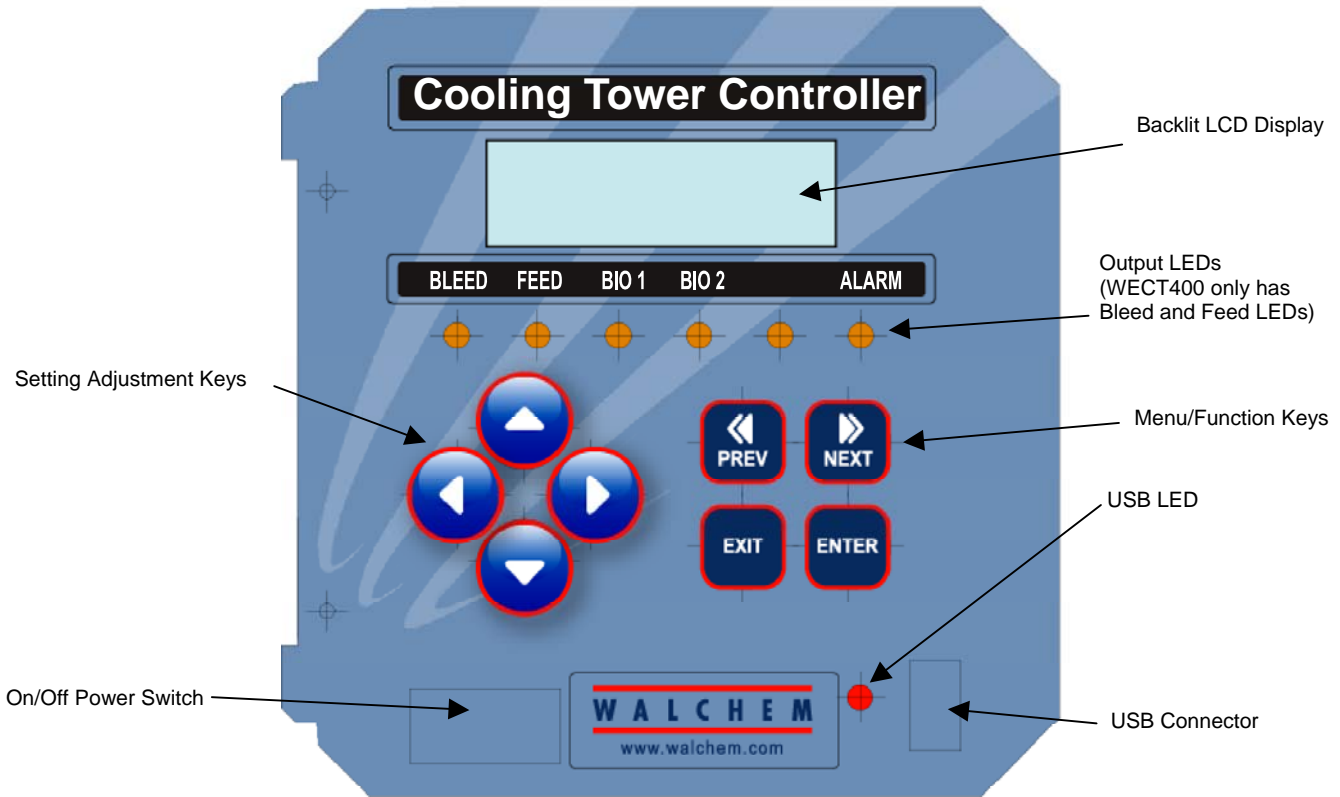

Figure 5 Front Panel

4.2 Display

A summary screen is displayed while the WECT controller is on. This display shows a bar graph of the conductivity relative to the set point, the actual conductivity value, and current operating conditions. The center of the bar graph is at the (S), which represents the set point. For each 1% rise above the set point a vertical bar appears to the right of the (S). For each 1% drop below the set point a vertical bar appears to the left of the (S). There are small breaks in the bars at each 5%. The bar graph is limited to displaying 20% above or below the set point. When these limits are reached an (L) or (H) may appear at the end of the bar graph to indicate a low or high alarm. The operating conditions that are displayed on the bottom line of this display are Bleed, Chem Feed, Cond Hi/Lo Alarm, Sampling, Waiting, No Flow, Biocide Pre Bleed, Bleed Timeout, Biocide Add, Biocide Lockout, Sensor Error, Temperature Error, and Normal. Normal just means there is nothing unusual to report.

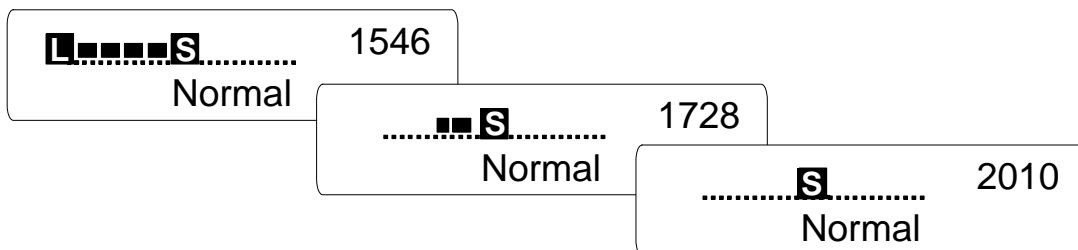
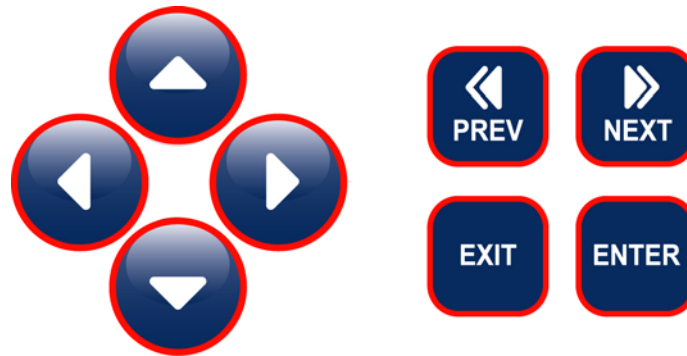

Figure 6 Summary Screen

4.3 Keypad

The keypad consists of 4 directional arrow keys and 4 function keys. The arrows are used to move the adjustment cursor and change settings, while the function keys are used to enter values, and navigate the various menu screens. The function keys are **ENTER**, **EXIT**, **NEXT**, and **PREV** (previous). **NEXT** and **PREV** scroll through the various menu choices. **ENTER** is used to enter a submenu and to enter a value. **EXIT** is used to back up one menu level. If you are at the main menu level, **EXIT** will return you to the Summary Display.



To change a value in a submenu, the left/right arrow keys move the cursor left and right to each digit or option that can be changed. The up/down arrows will change numeric values up or down, or scroll through option choices. Press **ENTER** only when you have finished making all of the changes for that menu screen.

4.4 Access Code

The WECT series controller is shipped with the access code disabled. If you wish to enable it, see Section 5.11 for operation. With the access code enabled, any user can view parameter settings, but not change them. Note that this provides protection only against casual tampering. Use a lock on the cover latch if you need more protection.

4.5 Startup

Initial Startup

After having mounted the enclosure and wired the unit, the controller is ready to be started.

Plug in the controller and turn on the power switch to supply power to the unit. The display will briefly show the WECT model number and then revert to the normal summary display. Scroll through the menus and calibrate the conductivity reading, temperature, and set the control parameters detailed in Section 5, Operation.

When programming the controller for the first time, you must *follow the sequence listed below* to insure an accurate calibration:

- Set the Sensor Type (conductivity range) in the Conductivity Menu for the sensor installed as described in Section 5.3.
- Set the desired units of measure in the Conductivity Menu as described in section 5.2.
- Calibrate the temperature in the Temperature Menu as described in section 5.3.
- Set the Zero Calibration in the Sensor Menu to compensate for any offset introduced by the sensor or electronics. See Section 5.2.
- Calibrate the conductivity sensor in the Sensor Menu as described in section 5.2.

To return to the summary display, press the **EXIT** key until you return to this screen. The controller will automatically return to this screen after 10 minutes.

Normal Startup

Startup is a simple process once your set points are in memory. Simply check your supply of chemicals, turn on the controller, calibrate it if necessary and it will start controlling.

4.6 Shut Down

To shut the WECT controller down, simply turn off the power. Programming remains in memory.

5.0 OPERATION

These units control continuously while power is applied. Programming is accomplished via the local keypad and display.

To view the top level menu, press any key. The menu structure is grouped by inputs and outputs. Each input has its own menu for calibration and unit selection as needed. Each output has its own setup menu including set points, timer values and operating modes as needed. After ten minutes of inactivity in the menu, the display will return to the summary display. Keep in mind that even while browsing through menus, the unit is still controlling.

5.1 Main Menu

The exact configuration of your WECT controller determines which menus are available as you scroll through the settings. Certain menus are only available on the WECT410 controller, and others will change if you select certain options. All settings are grouped under the following main menu items.

Conductivity	
Temperature	
Bleed	
Feed	
Totalizer	WECT410 Only if Water Contactor or Paddlewheel Feed mode is selected.
Bio 1	WECT410 Only
Bio 2	WECT410 Only
Time	
Alarm	
4-20mA	Only if 4-20mA option installed
Access Code	
Datalog	Only if advanced USB feature is in model code
Config	Only if advanced USB feature is in model code
Upgrade	

The **NEXT** key travels forward through this list while the **PREV** key travels backwards through the list. Pressing **ENTER** will Enter the lower level menu that is currently displayed.

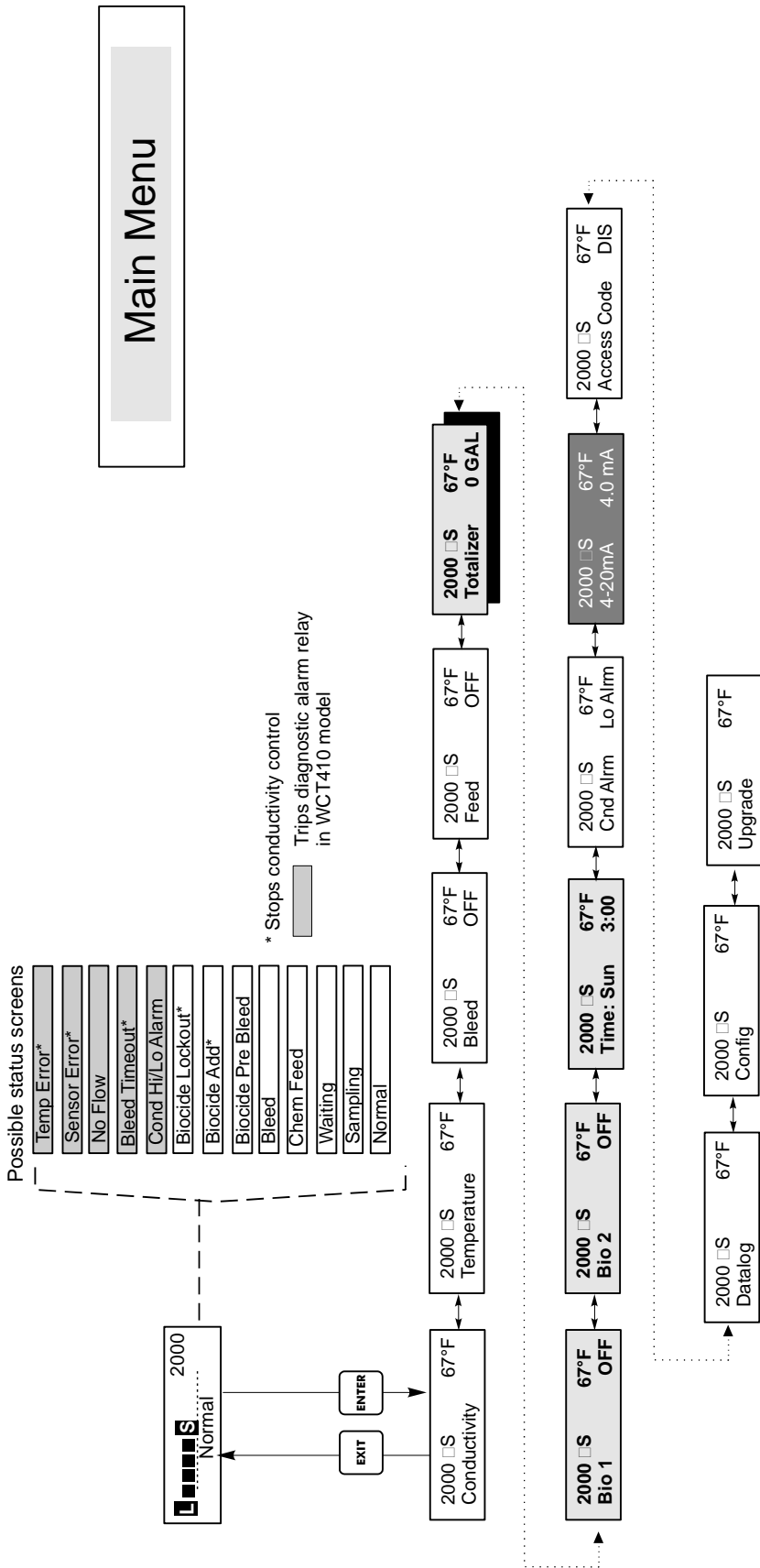

Operation

- Press Enter key to enter menu.
- Press Exit key to exit menu.
- Blinking fields may be edited with the adjust arrows.
- Press Enter when modification is complete to return to Main Menu Level.

Legend

- Menu only appears when water meter contactor or Paddlewheel feed mode is selected.
- Menu only appears when 4-20 mA hardware is installed.
- Menu only appears in WCT410 model..

Figure 7 Main Menu

5.2 Conductivity Menu



The conductivity menu provides the following settings: Calibration, Self Test, Unit selection, and sampling mode setup. Additional settings are also discussed below. Refer to figure 8, Conductivity Menu Chart.

Calibrate	To Calibrate the conductivity, use either a hand held meter, or a buffer solution, and adjust the WECT controller to match. Once Calibrate is entered, the unit continuously displays conductivity readings. Press an arrow key to change the value displayed to match the hand held meter or the buffer solution. You must press ENTER to activate the new calibration. You must press the EXIT key to exit calibration. The Bleed output is unaffected until the calibration menu is exited, so if it was ON when you entered calibration it will stay on until you exit.
Zero Cal	This menu is used to calibrate the sensor to read precisely zero when it is dry. It should be set at installation with dry sensor in air. This zero procedure should be repeated if the range is changed or a new sensor is installed. Press ENTER to start the zero calibration procedure. When asked "Sensor in air?", remove the sensor from the process bath and dry it off. Use the arrow key to change the "N" to "Y" and press ENTER . You will be asked to press ENTER when the reading on the top line is stable. If the sensor offset was less than $\pm 20\%$ of full scale, the display will flash "Cal Successful" and return to the zero adjust display. You may now press EXIT . If the message "BadZero: CalFail" appears, the offset was too large for the software to compensate. Check to see that the sensor is out of the bath and is dry and that all wiring connections are correct. If none of these corrects the problem, install a new sensor.
Self Test	Press ENTER to begin self test. Press any key to stop. Self Test internally simulates a conductivity sensor and should always give the reading $1000 \mu\text{S}/\text{cm} \pm 100 \mu\text{S}$. If it does not, there is a problem with the electronics and unit should be serviced. The the self-test is in the expected range, and there is a problem calibrating, then the sensor or its wiring is at fault.
Units	You may choose to display conductivity in $\mu\text{S}/\text{cm}$ or in ppm. Press ENTER and then use the Up and Down arrows to change the units. If you change the units, you will be warned to check your settings. This is important. Set points are not automatically translated from $\mu\text{S}/\text{cm}$ to ppm. If you change the units you will need to change your Bleed settings.
ppm C.F.	This is the ppm Conversion Factor (or multiplier). This is typically 0.666 but can be changed to accommodate various requirements.
Sample Mode C / I	Press enter to choose Continuous sampling or Intermittent sampling. A 'C' at the end of the display means that sampling is continuous, while an 'I' indicates intermittent sampling. Use Continuous sampling with a traditional bypass line installation of the conductivity sensor. Choose Intermittent sampling to use the bleed solenoid valve for timed sampling of the conductivity. Intermittent sampling installations read the conductivity at set intervals for a given sample duration. If the conductivity is above the set point, the valve that controls the sampling will stay open until the conductivity falls below the set point. If the time the valve stays open goes beyond the sample duration, the controller will display Xtnd on the top status line, as well as the amount of time extended. A limit on this amount of time may be imposed; see Figure 10 Bleed Menu.
	Continuous
	Intermittent If Intermittent sampling is chosen, the Flow Switch input will be ignored, and the following two settings will become available:
Interval	This sets the amount of time between samples. This is set in Hours:Minutes.
Duration	This is the length of each sample. This is set in Minutes:Seconds.
Damping	This menu is used to set the desired amount of software damping of the conductivity sensor signal, in order to prevent rapid fluctuations in the reading. If you are seeing large changes in the conductivity reading, increase the damping until the reading is stable. Press ENTER to change the damping. Use the UP or Down arrow keys to scroll through the available options. Press ENTER again when the desired choice is displayed.

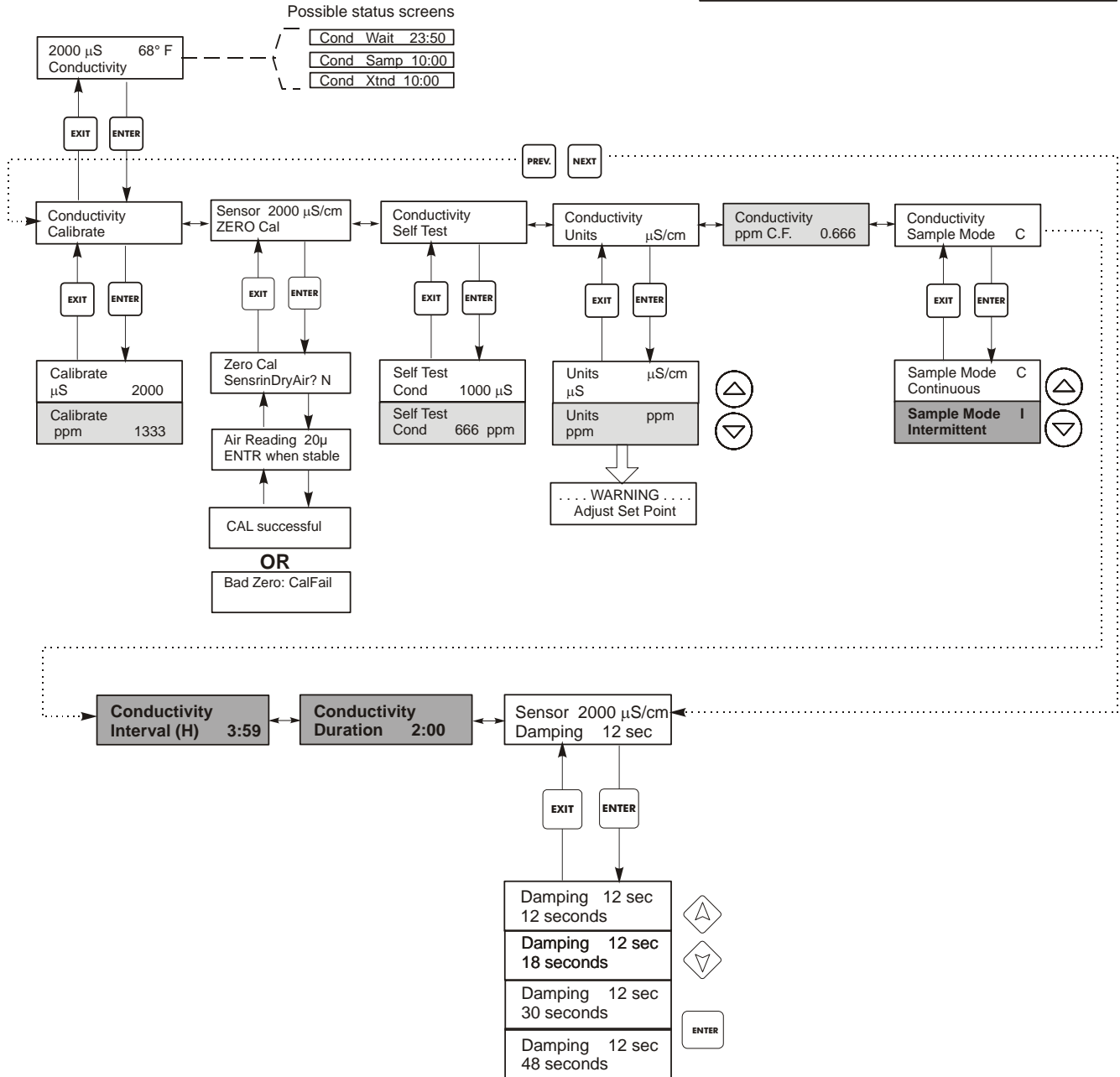
Conductivity Menu



Legend

-  Menu choices that appear when ppm units are selected.
-  Menu choices that appear when intermittent sampling is selected.

Operation

- Press Enter key to enter menu.
- Press Exit key to exit menu.
- Blinking fields may be edited with the adjust arrows.
- Press Enter when modification is complete to return to Conductivity Menu Level.

Figure 8 Conductivity Menu

5.3 Temperature Menu

The Temperature menu contains the following settings: Calibration and Units (if the Temp element is detected when the unit is powered on) or Manual Temp and Units (if no Temp sensor is detected at power up). Refer to the Temperature Menu chart, figure 9.

If a "Temp Error" message appears or if the "Man Temp" menu appears after the unit is powered on, it indicates the temp element is not working properly. Refer to the Troubleshooting Section.

Calibrate	To Calibrate the Temperature, use a thermometer to measure the fluid temperature and adjust the WECT controller to match. Once Calibrate is entered, the unit continuously displays temperature readings. Press the Up or Down arrow key to change the value displayed to match the thermometer. You must press ENTER to activate the new calibration. You must press the EXIT key to exit calibration.
Man Temp	This menu appears only if no temperature element is connected at power-up. Use the arrow keys to adjust the temperature displayed to match that of the water.
Units	You may choose to display temperature in °C or °F. Press ENTER and the Up or Down Arrow keys to change the temperature units for display.

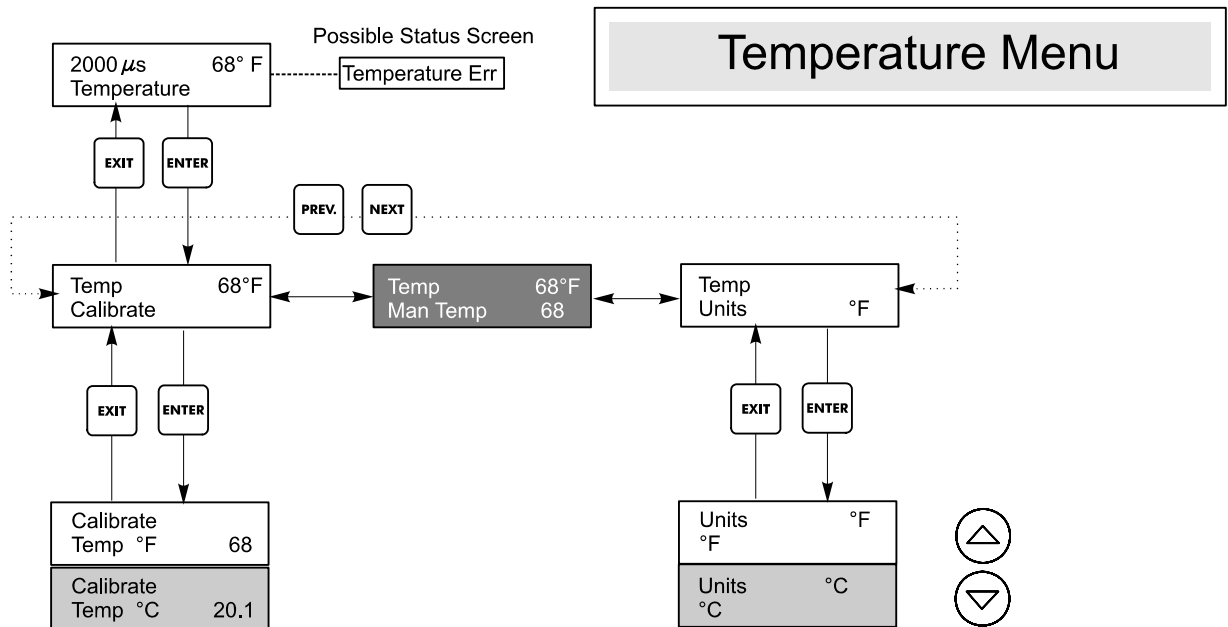

Legend

- Menu wording that appears when °C units are selected.
- Menu wording that appears when Automatic Temperature Compensation is selected.
- Menu wording that appears when Manual Temperature Compensation is selected.

Figure 9 Temperature Menu

5.4 Bleed Menu

The Bleed Menu provides the following settings: Set Point, Dead Band, Control Direction, HOA. The Bleed menu will be indicated on the display by one of the following: (The 'A' indicates that the output is being controlled automatically.)

Bleed A	OFF	Indicates that the bleed output is currently OFF.
Bleed A	10:00	Indicates the length of time that the Bleed output has been ON.
Bleed A	NO FLOW	Indicates that bleed control has been suspended because there is presently no flow past the flow switch.
Bleed A	LOCKOUT	Indicates that the output is currently locked out due to a biocide add or biocide lockout.
Bleed A	TIMEOUT	Indicates that the bleed output has been on longer than the Time Limit.

Set Point	This is the conductivity value at which the bleed solenoid valve is turned ON. The factory default setting for the WECT controller is for the Bleed output to turn on when the conductivity is higher than the set point. This may be changed at the Control Direction screen.	
Dead Band	This is the conductivity value that when combined with the set point determines when the bleed output turns OFF. Assuming that the control direction is set for normal operation (High Set Point) the bleed output will turn off when the conductivity drops below the set point minus the Dead Band. For example: The set point is 1500 μ S/cm and the Dead Band is 200 μ S/cm. The bleed output turns ON when the conductivity reading is greater than 1500 but does not turn OFF until the conductivity drops below 1300.	
Time Limit	This menu allows you to set a maximum amount of time for the bleed. The limit time is programmed in hours and minutes and can be set between 1 minute and 8 hrs: 20 minutes. If the time limit is set to zero, then the valve may be open indefinitely. If the maximum time is exceeded, the bleed valve will close and will not re-open until the "Reset Timer" menu is reset by an operator.	
Reset Timer	Only appears if the time limit above has been exceeded. Use the up or down arrow to change "N" to "Y", then press ENTER.	
Control Dir H / L	This allows you to set the Normal (High Set Point) or Inverse (Low Set Point) operation of the bleed output. When set to High, the output turns on when the conductivity is higher than the set point. When set to Low, the output turns on when the conductivity is lower than the set point.	
	High Set Point	Low Set Point
H O A	The "Hand Off Auto" screen allows you to select the operating mode of the bleed output. In Hand (manual) mode, the output is turned on immediately for a maximum of 10 minutes. If you walk away the output will return to Auto mode at the end of that time. In Off mode the output will stay Off indefinitely. In Auto mode the bleed output will respond to changes in conductivity based on the set point. The HOA mode of the bleed output is indicated on the bleed status lines.	

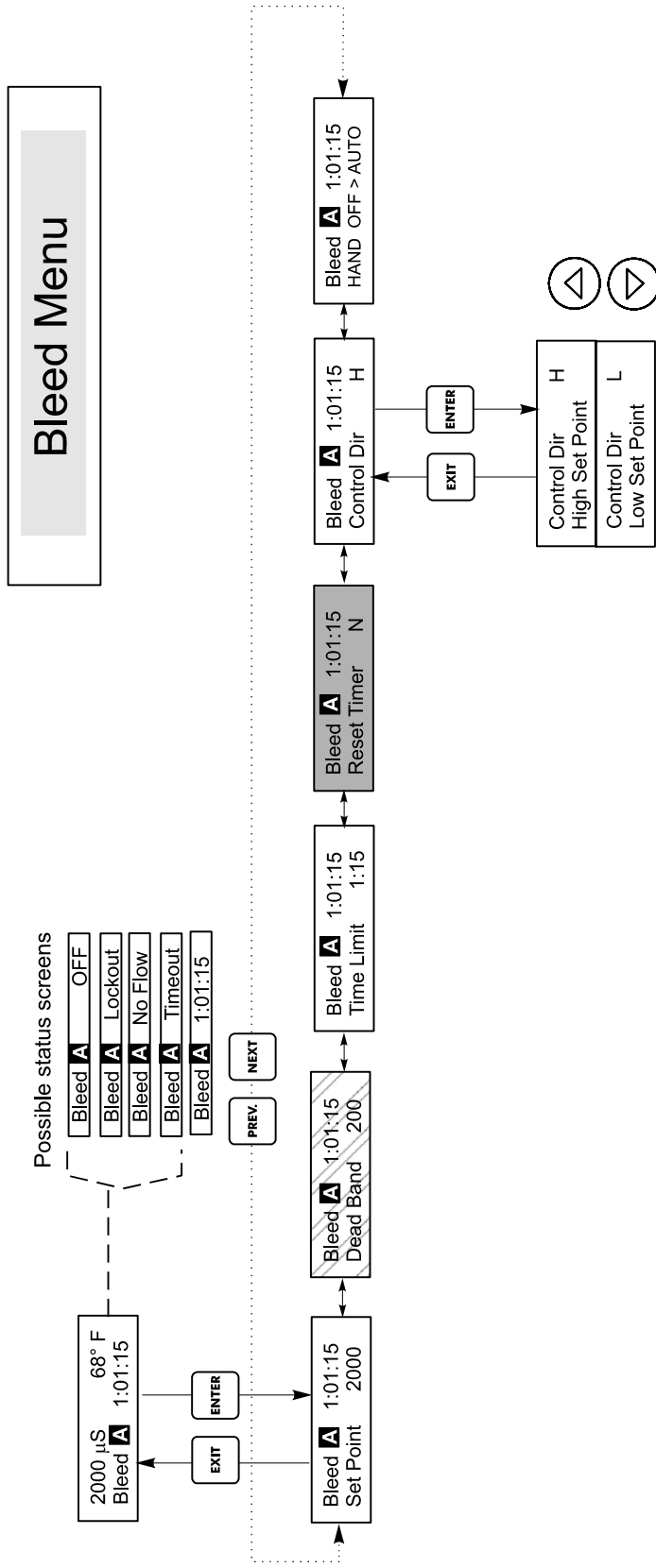



Figure 10 Bleed Menu

Legend

-  Appears only if limit timer has expired.
-  Appears only in continuous sample mode.

Operation

- Press Enter key to enter menu.
- Press Exit key to exit menu.
- Blinking fields may be edited with the adjust arrows.
- Press Enter when modification is complete to return to Bleed Menu Level.

5.5 Feed Menu

The Feed Menu adapts to the selected Feed output mode.

Hint: For easiest programming, program Feed Mode first, then step through the rest of the feed parameters. The modes are defined as follows:

A	Bleed and Feed with Optional Lockout	Bleed and Feed Mode turns the Feed output On and Off at the same time as the Bleed output. The lockout setting determines the maximum allowable time for the Feed output. If this time is exceeded the Feed output is turned off and Locked out until the Bleed output turns off.
B	Feed % of Bleed	Feed % of Bleed Mode tracks the length of time that the Bleed output is on. When the bleed turns off the feed output is energized for a user defined proportion of the bleed time.
C	Feed % of Time	Feed % of Time Mode turns on the Feed output for a user definable % of a timed cycle. The time cycle length is adjustable from 10 to 60 minutes.
D	Feed based on Water Contactor Input	Feed based on Water Contactor Input Mode turns on the Feed output for a user definable time each time a water contactor pulse is detected. This contactor input can be divided to accommodate a large variety of water meters. Contacts will accumulate feed time so that all contacts are accounted for.
E	Feed based on Paddlewheel Input Mode	Turns on the Feed output for a user definable time each time a defined volume of flow is detected. This paddlewheel input has a programmable K Factor to work with a large variety of Hall Effect (square wave, not sine wave) flow meters.

The Feed menu will be indicated on the display by one of the following: (The 'A' indicates that the feed is being controlled automatically.)

Feed A	OFF	Indicates that the Feed output is currently OFF.
Feed A	10:00	Indicates the length of time that the Feed output has been ON or the length of time that the Feed output will be ON.
Feed A	NO FLOW	Indicates that Feed control has been suspended because there is presently no flow past the flow switch.
Feed A	TIMEOUT	Indicates that the feed lockout timer in the Bleed and Feed mode has expired.
Feed A	LOCKOUT	Indicates that the output is currently locked out due to a biocide add or biocide lockout.

Bleed and Feed Mode	Lockout Set this for the Feed Lockout Time. The lockout time is the maximum length of time that the feed output can be on. If the lockout time is set to 0:00, the lockout timer is no longer used and the feed output will be on for as long as the bleed is on.
Feed % of Bleed Mode	% of Bleed This is the % value that is multiplied times the accumulated bleed time to determine how long the feed will be. For example, if the bleed was on for 10 minutes and this setting was 50%, the feed output would be on for 5 minutes.
	Max Time This is similar to the lockout time above in that the feed output will not exceed this maximum length.
Feed % of Time Mode	% of Time This is the % value that is multiplied times the cycle length to determine the length of time that the feed output is ON. If the cycle length were 10 minutes and this setting was 40%, the feed output would be on for 4 minutes, then off for 6 minutes and then repeat the cycle.
	Cycle Time This determines the length of the cycle to be used.

Feed Based on Water Contactor Mode	Time/Cont. (Time per contact.) This determines the length of time that the feed pump should be on for each contact that is received.
	÷ Contacts By This setting allows a divider to be entered. The divider will count actual contacts from the meter until the setting is reached before a contact is considered to be received. For example, if the divider is set to 10 and the Time/Cont is set to 5:00, then the feed output would turn on for 5:00 minutes after 10 contacts were received.
	Time Limit This setting puts a limit on the amount of time that can be accumulated by the water meter input. Once this setting has been reached, all contacts will be ignored until the accumulated feed time expires. By setting Time Limit = Time/Cont., the accumulation of contacts can be disabled.
Feed Based on Paddlewheel Mode	Time/Vol This setting determines the pump on-time once a given volume of water has passed through the paddlewheel sensor. The volume required to initiate feed is set below.
	Vol to Init. This setting determines the volume of makeup water that will initiate chemical feed.
	K Factor Enter the number of pulses per unit volume that the paddlewheel sensor sends out. This value is usually printed on the sensor's flow cell or in its instructions.
	Time Limit This setting puts a limit on the amount of time that can be accumulated by the water meter input. Once this setting has been reached, all contacts will be ignored until the accumulated feed time expires. By setting Time Limit = Time/Vol., the accumulation of contacts can be disabled. This is set in minutes and seconds. The following settings are for all feed modes.
Chem Feed Mode A / B / C / D / E	This allows the user to select the chemical feed mode as described above.
H O A	This sets the Hand Off Auto for the feed output. This was explained in the Bleed Menu section and functions similarly. In Off position, the output will not turn ON regardless of the feed mode selected.

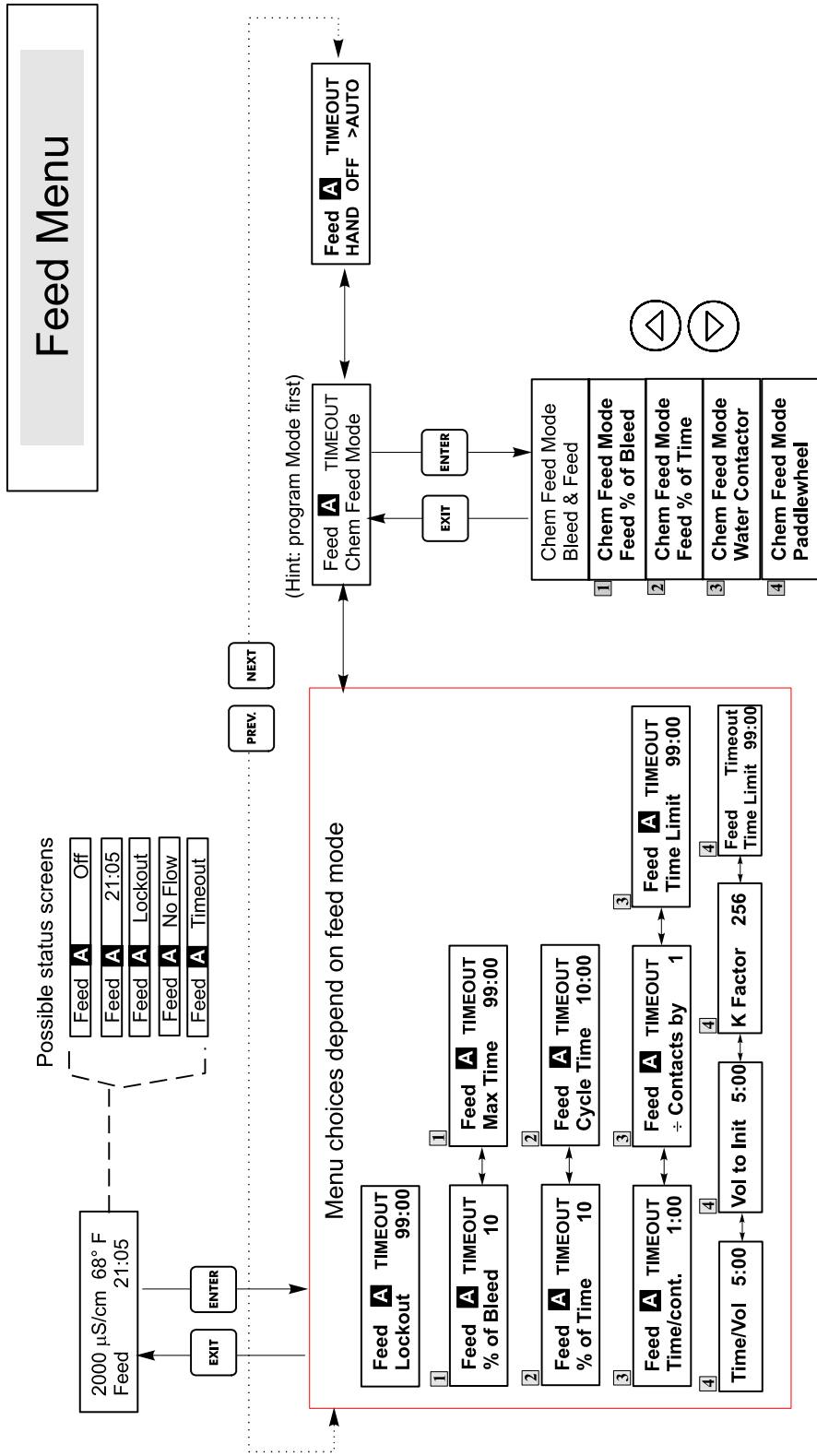

Figure 11 Feed Menu

Operation

- Press Enter key to enter menu.
- Press Exit key to exit menu.
- Blinking fields may be edited with the adjust arrows.
- Press Enter when modification is complete to return to Feed Menu Level.
- Press Enter or Adjust arrow to turn on/off output at Hand menu.

Legend

- 1 Menu choices that appear when Feed as % of Bleed mode is selected.
- 2 Menu choices that appear when Feed as % of Time mode is selected.
- 3 Menu choices that appear when Feed based on Water contactor input is selected.
- 4 Menu choices that appear when Feed based on Paddlewheel input is selected.

5.6 Totalizer Menu

The Totalizer menu is only available on the WECT410 controller, and is only visible when the feed mode has been set to the Water Contactor mode or Paddlewheel mode. The Totalizer menu will be indicated on the display as follows:

Tot 100 Gal or Liters

Reset Totalizer N	This allows you to restart the totalizer display. Press the Up or Down arrow key to change the N to Y and press ENTER to reset the totalizer to 0 gal. The totalizer will count up to a maximum of 99,999,999. After that it will reset itself to zero.
Vol/cont Only appears if the Chem Feed mode is Water contactor.	This allows you to set the volume of makeup per contact from the water meter.
Tot Units	This is used to set the units of measure for the totalizer. Press ENTER, then use the up and down arrow keys to toggle between "Gallons" and "Liters." Press ENTER when the desired choice is displayed.

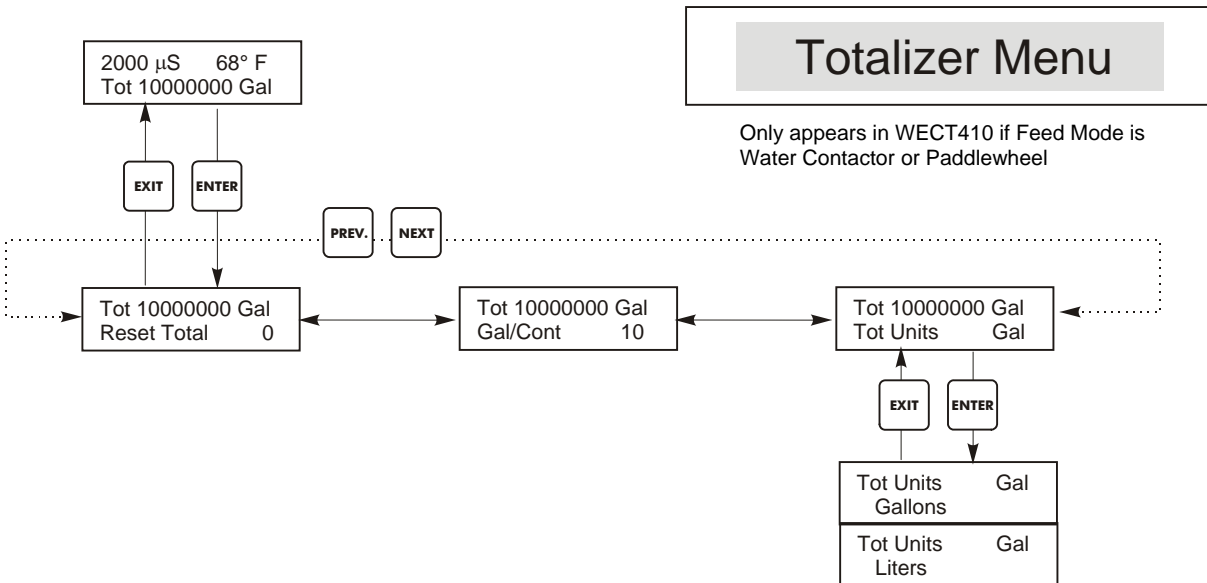

Figure 12 Totalizer Menu

5.7 Bio1 and Bio2 Menus

These menus are only available on the WECT410 controller. The Bio 1 and Bio 2 menus are separate from each other but operate in exactly the same way. Each menu provides the following independent settings: Prog Bio Adds, Bio Pre-Bleed, Bio Lockout Time, Set Bio Mode, HOA. Bio menus may display the following screens:

Bio 1 A	OFF	Indicates that the Bio 1 output is off.
Bio 1 A	PENDING	Indicates that Bio 1 is ready to begin a biocide cycle but is unable to begin due to NO FLOW, or Bio 2 already ON.
Bio 1 A	PRE BLD	Indicates that Bio 1 is in the Pre-Bleed portion of its cycle.
Bio 1 A	4:50	Indicates that Bio 1 is adding and has 4 minutes and 50 seconds remaining to add, or that there are 4 hours and 50 minutes of Bio 1 Lockout remaining. If the Bio 1 LED is ON, the timer is for the Add. If the LED is OFF, the timer is for remaining lockout time.
Bio 1 A	NO FLOW	Indicates that there is no biocide activity and none is pending and that there is no flow past the flow switch.

Note: When programming the unit for the first time, it is recommended that the Biocide Add Mode be chosen first, then step through the rest of the Biocide Add menu indicated below and in figures 13 and 14. This will make programming simple and logical.

A number of built-in interlocks are part of the biocide feed program. When one biocide relay activates, the other biocide will be locked out until the first biocide finishes its control cycle. Similarly, the bleed relay is locked out once the biocide cycle begins (except for the pre-bleed portion of the cycle). Bear this in mind, especially if the biocide feed time is very long or very frequent...very little time is left in the day to control the conductivity.

The inhibitor feed relay interaction is more complex.

For Bleed and Feed mode	Since the bleed relay is locked out, the feed relay will be locked out as well.
For Feed as % Bleed	If the bleed is adjacent to the start of the biocide cycle, or is during the pre-bleed part of the cycle, the feed time does not occur.
For Feed as % Time	The feed relay is locked out during the biocide add, the feed events are not stored in memory, but the feed cycle time is reset once the biocide add cycle is over, so that as soon as the biocide cycle is complete, one feed cycle will occur.
For Water Contactor or Paddlewheel mode	The water flow is stored in memory, up to 256 contacts, and the correct feed time is activated once the biocide cycle has completed.

<p>Prog Bio 1 Add</p>	<p>Press ENTER here to see a list of all of the biocide adds presently scheduled. The first screen displayed is for Today's Biocide add. Use the NEXT key to see Tomorrow's add or the PREV key to see Yesterday's add. Use the arrow keys to edit the starting time or length of the add. The screen should look similar to the one below:</p> <pre style="margin-left: 40px;">Prog Bio 1 Add 2Mon 10:00 45</pre> <p>The bottom line indicates that on the second Monday in a multi-week cycle, Bio 1 will begin its Biocide Addition cycle at 10 AM and will add for 45 minutes. If the biocide output does not come on at exactly 10 AM, there may be NO FLOW, or there may be a conflict with Biocide output 2. If either of these conditions is true, the output will be delayed until the flow has been restored, or the Biocide 2 lockout time is completed. The times are set in a 24 hour format, so 1 PM is entered as 13:00. The WDT supports daily cycles, 1 week cycles, 2 week cycles and 4 week cycles. It is not necessary for both biocide outputs to be on the same cycle.</p> <p>Press the EXIT key to exit the Prog Bio 1 menu. There are separate Bio 1 and Bio 2 Program menus and separate program memories, allowing addition of each biocide independently.</p>							
<p>Pre Bleed</p>	<p>This setting provides a Pre Biocide Add Bleed Conductivity Set Point. Pre Bleed is the first step in a biocide addition. The operating conductivity must be lower than this setting before the biocide output will turn ON. If the conductivity is higher than this set point, the bleed output is turned on to lower the conductivity. This setting is independent of the bleed set point in the Bleed Menu. There are separate Bio 1 and Bio 2 Pre Bleed settings. To disable the Pre Bleed, set this value higher than your operating set point or set the value to zero.</p>							
<p>Lockout</p>	<p>This setting determines how long bleed and additional biocide adds will be locked out after completing a biocide add. This value is set in hours and minutes. There are separate Bio 1 and Bio 2 settings. This can be set to 0 if it is not desired.</p>							
<p>Bio 1 Add Mode 1</p>	<p>The last digit indicates that Bio 1 adds are scheduled on a 1 week repeating cycle. To change this, press the ENTER key and then use the Up or Down arrow keys to select the appropriate choice. Biocide cycles may be daily (up to ten times per day) or 1, 2, or 4 weeks long. This is provided to save you some programming effort. If you add the same thing every week, use the 1 week cycle. If you wish to add Biocide 1 only once every two or four weeks use the 2 or 4 week cycle. If you wish to add Biocide 1 more than once a day, choose the daily cycle.</p> <p>The Bio 1 cycle length is not affected by the Bio 2 cycle length. In weekly cycle modes, the WDT can schedule one add per day for each Biocide output for up to 4 weeks. If a daily cycle is chosen, that biocide can be added up to ten times per day, every day.</p> <table border="1" data-bbox="570 1052 1464 1098" style="width: 100%; border-collapse: collapse;"> <tr> <td style="width: 25%; text-align: center;">1 Week</td> <td style="width: 25%; text-align: center;">2 Week</td> <td style="width: 25%; text-align: center;">4 Week</td> <td style="width: 25%; text-align: center;">Daily</td> </tr> </table>				1 Week	2 Week	4 Week	Daily
1 Week	2 Week	4 Week	Daily					
<p>H O A</p>	<p>This is the Hand Off Auto selector screen for the Biocide output. There are separate settings for Bio 1 and Bio 2. <u>In the Off position Biocide adds can be missed.</u> See the description in the Bleed menu for more details about HOA settings.</p>							

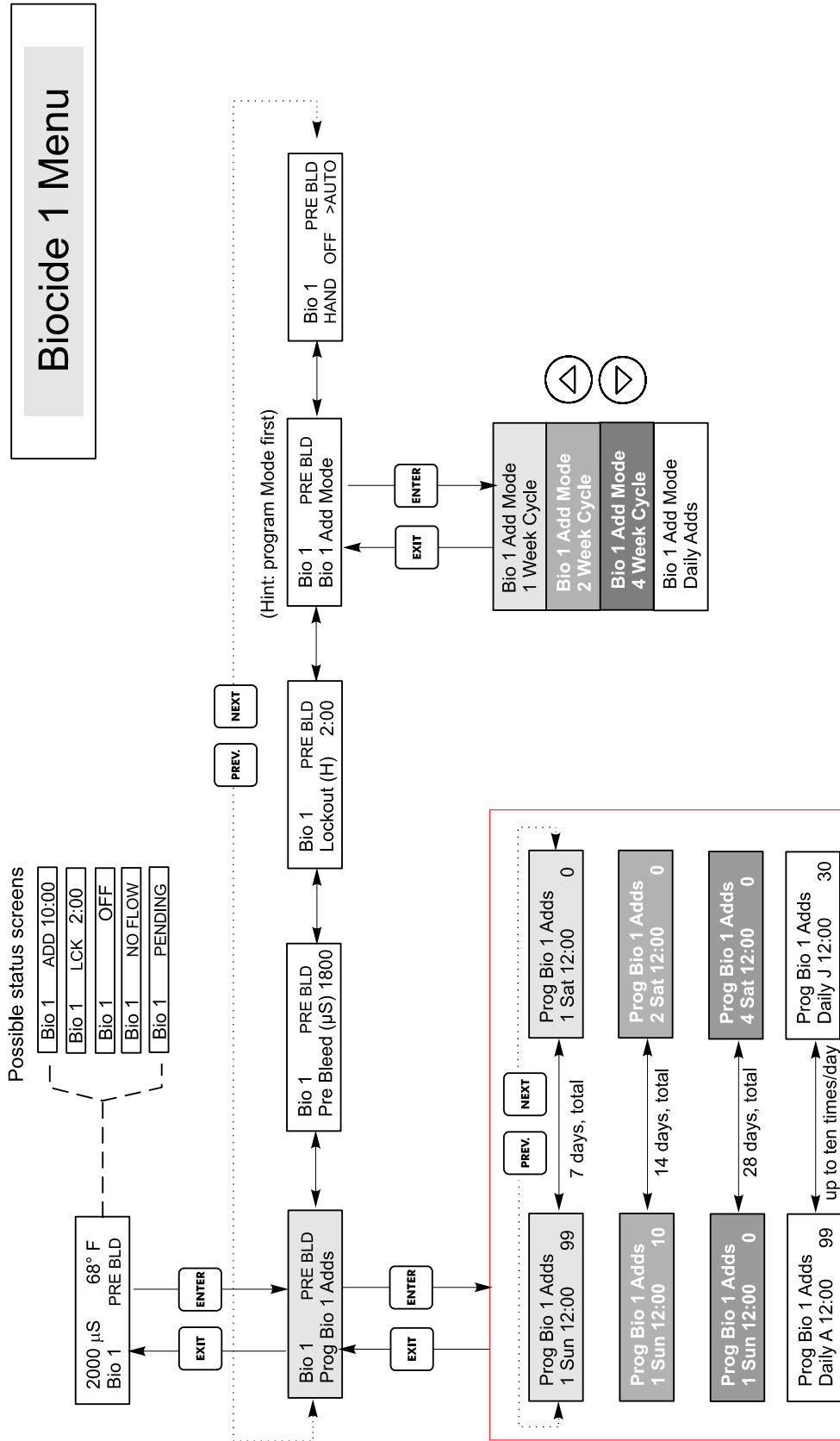

Figure 13 Biocide 1 Menu

5.8 Time Menu

This menu has only one choice, to set the Time used for Biocide adds (WECT410) or Datalogs. This menu will appear as follows:

Time: 2Mon 10:20

Set Time	Press ENTER to set the Time. Use the arrow keys to adjust the day and time and then press ENTER to store or EXIT to discard. If either biocide is set for a 2 or 4 week cycle, you can change the current week in the cycle by changing the week number. If the longest biocide cycle is 2 weeks, the 3Sun through 4Sat choices are not shown.
-----------------	--

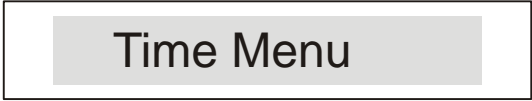

Time Menu is only present if Biocide Option is installed.

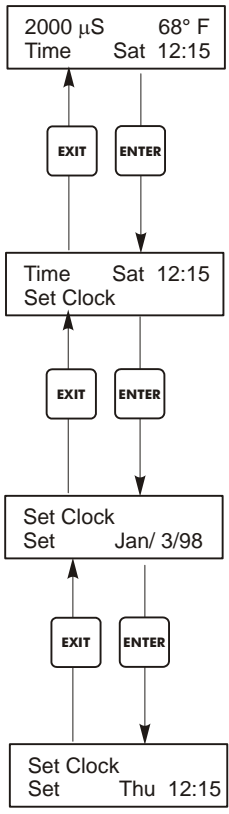

Figure 15 Time Menu

5.9 Conductivity Alarm Menu

This menu is available for both WECT400 and WECT410 series controllers, however, only the WECT410 has a relay output for the alarm. On both units the settings here determine when the (L) and (H) indicators appear on the summary screen. The Alarm menu screen will appear as follows:

Cnd Alrm OFF
 Cnd Alrm LOW ALRM
 Cnd Alrm HI ALRM

Set % Low	This is the % below the bleed set point that the LOW ALARM will activate. If the conductivity set point is 1000 and the % Low setting is 20 then the Low alarm will activate at 800. The alarm can be disabled by setting it to zero.
Set % High	This is the % above the bleed set point that the HIGH ALARM will activate. If the conductivity set point is 1000 and the % High setting is 20 then the High alarm will activate at 1200. The alarm can be disabled by setting it to zero.

Cnd Alrm Menu

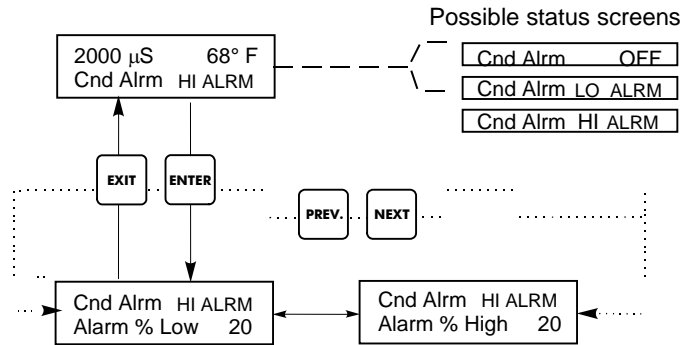

Figure 16 Conductivity Alarm Menu

5.10 4-20mA Menu

This menu is only available if the 4-20mA output is installed in the controller. The 4-20mA output is available for either the WECT400 or WECT410 series controllers. This menu provides for scaling and calibrating the output. The 4-20mA menu screen appears as follows:

4-20mA 9.20mA

This indicates that the current output of the 4-20mA card is 9.20 mA.

Set 4mA Pt	This conductivity setting will correspond to a 4 mA output from the controller.
Set 20mA Pt	This conductivity setting will correspond to a 20mA output from the controller.
Calibrate	This will provide fixed 4mA and fixed 20mA outputs to allow you to calibrate connected equipment.

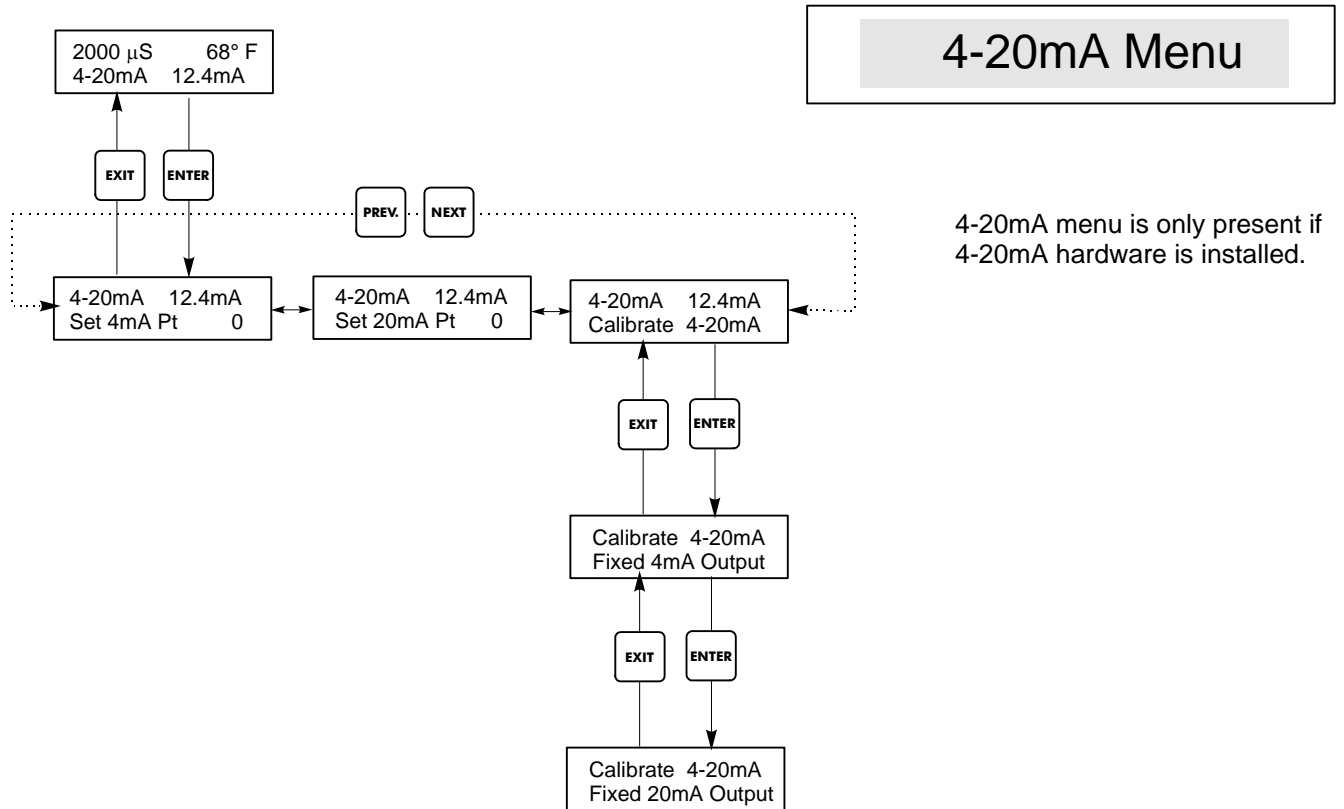

Figure 17 4-20 mA Menu

5.11 Access Code Menu

This menu determines whether the access code feature of the controller is enabled or disabled and allows you to customize the access code to your own value. The access code controls whether or not you are allowed to change the parameters in the controller. With the access code disabled, any user may change any parameter. With the access code enabled, any user can view any parameter, but cannot change them. Once an attempt is made to change a parameter, the display will prompt the user to enter the access code. If the correct access code is entered, the parameters can be changed. If the wrong access code is entered the parameters cannot be changed. Once the access code has been correctly entered, it will remain valid until there is a period of 10 minutes without a key being pressed. The access code menu will appear as shown below:

The access code menu will appear as shown below:

Access Code	DIS	Indicates that the access code is disabled. No access code is required to change any setting.
Access Code	REQ	Indicates that the access code is required to alter settings.
Access Code	OK	Indicates that the access code is required and has been entered correctly.

Enable N / Y	Press the Up or Down arrow key to change the N to Y and press ENTER to enable the access code feature. If the access code is enabled you must first enter the access code to disable it.
New Value	<p>Press ENTER to display the current access code value and use the arrow keys to change it to any value between 0 and 9999. If the access code has been enabled, you will be prompted to enter the current access code before being allowed to change it. You must remember the access code if you enable it.</p> <p>The Factory default Access code is 1995.</p> <p>If you change the access code and can't remember it follow this procedure:</p> <ol style="list-style-type: none"> 1. Turn off power to the controller. 2. Wait 10 seconds. 3. Press and Hold the UP and DOWN arrow keys while turning on the power. 4. Read the access code on the display. 5. Release the keys, and the access code will disappear.

Access Code Menu

Any Top Display
Access Code 0000

The Access Code prompt may appear at any screen in the entire menu structure if the current access code has not been entered by the user. Access code entries will be valid for 10 minutes from the most recent key press.

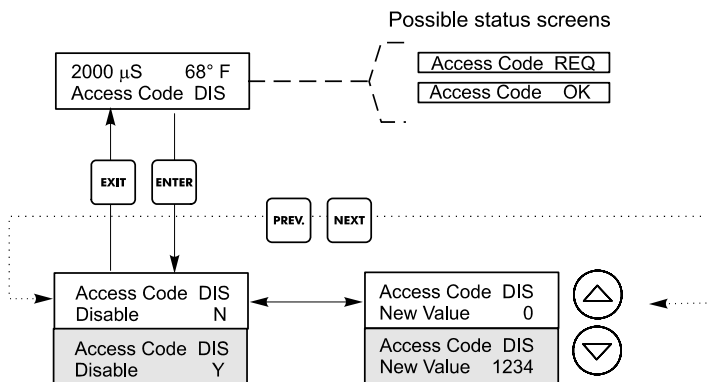

Enter any four digit code

Figure 18 Access Code Menu

5.12 Datalog Menu

This menu is available on both the WECT400 and WECT410, if the data logging option has been purchased. This is indicated in the model code by the letter U at the end of the model code. This menu allows you to save data from the controller to a USB flash drive.

The controller has four logs, the Current Datalog, the Backup Datalog, the Event Log, and the Reset Log. All files are in a CSV format that may be opened in a spreadsheet such as Microsoft Excel.

- Current Datalog** Contains the following data taken at 10 minute intervals:
 Conductivity
 Temperature
 Water Meter Total
 When the current datalog is downloaded to a USB stick, it is erased and a new log file is started.
 If the current datalog is not downloaded before it reaches its maximum size (at least 60 days of data) the oldest data is overwritten by the newest data.
- Backup Datalog** Contains the same data as the current log but it is never erased. When the backup log reaches its maximum size (at least 60 days of data), the oldest data is overwritten by the newest data.
- Event Log** Contains columns for each relay and flow switch input, as well as the date and time. Each time any of these change state, the date and time is updated and it will show a 1 if the relay is on and 0 if it is off, and a 1 if the flow switch indicates no flow, 0 if there is flow. Tens of thousands of events will be recorded before the oldest data is overwritten by the newest, the number varying with the controller's configuration.
- Reset Log** Consists of time stamps of when power was lost, when it was returned, and the cause of the reset.

<p>Current or Backup Datalog</p>	<p>Place a USB flash drive with at least 10 MB capacity into the USB port on the front panel of the controller. Press the Enter key to download the file from the controller to the disk. The file name for the Current Datalog will be Datalog<serial number><date><time>.csv using the date and time it was downloaded. The file name for the Backup Datalog will be Datalog<serial number><date><time>.csv using the date and time it was created.</p> <p>The controller will display the progress of the file download process. If the file was successfully copied to the USB disk the controller will display Transfer Success.</p>		
<p>Copy Event Log</p>	<p>Place a USB flash drive with at least 10 MB capacity into the USB port on the front panel of the controller. Press the Enter key to download the file from the controller to the stick. The file name will be Eventlog<serial number><date><time>.csv.</p> <p>The controller will display the progress of the file download process. If the file was successfully copied to the USB disk the controller will display Transfer Success, otherwise Transfer Fail 1.</p>		
	<table border="1"> <tr> <td data-bbox="581 1241 1024 1289">Transfer Success</td> <td data-bbox="1024 1241 1469 1289">Transfer Fail 1</td> </tr> </table>	Transfer Success	Transfer Fail 1
Transfer Success	Transfer Fail 1		
<p>Copy Reset Log</p>	<p>Place a USB flash drive with at least 10 MB capacity into the USB port on the front panel of the controller. Press the Enter key to download the file from the controller to the stick. The file name will be Resetlog<serial number><date><time>.csv.</p> <p>The controller will display the progress of the file download process. If the file was successfully copied to the USB disk the controller will display Transfer Success.</p>		
	<table border="1"> <tr> <td data-bbox="581 1436 1024 1484">Transfer Success</td> <td data-bbox="1024 1436 1469 1484">Transfer Fail 1</td> </tr> </table>	Transfer Success	Transfer Fail 1
Transfer Success	Transfer Fail 1		

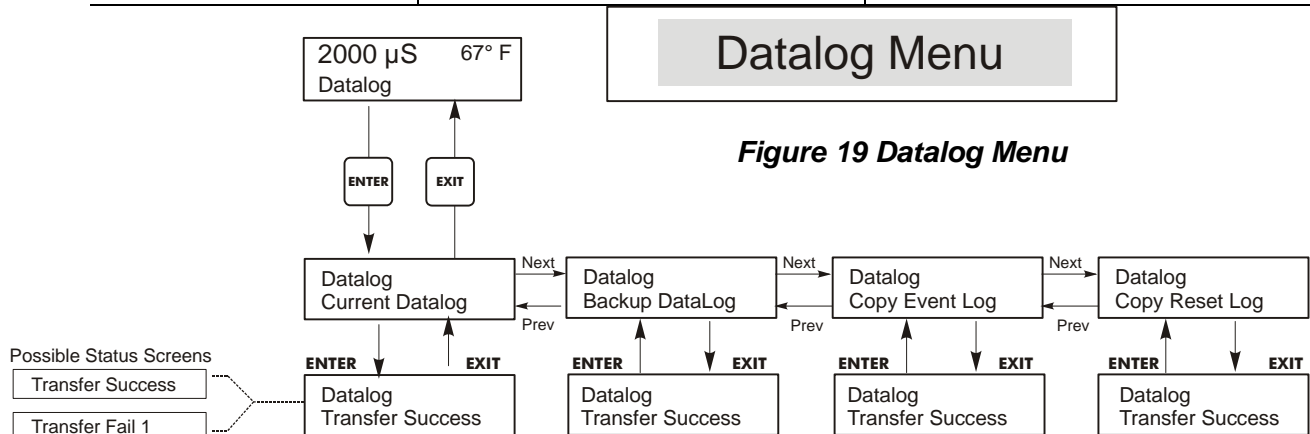

Figure 19 Datalog Menu

5.13 Config Menu

This menu is available on both the WECT400 and WECT410 models. It allows you to export a file that contains all of the set points in the controller to a USB flash disk drive, and then later import the set points into another controller.

Export Config	Place a USB flash drive with at least 10 MB capacity into the USB port on the front panel of the controller. Press the Enter key to export the configuration file from the controller to the stick. The file name will be UCF.ini. If you are exporting files with different set points you may rename the file to something that describes it, as long as it has an ini extension. The controller will display the progress of the file download process. If the file was successfully exported to the USB disk the controller will display Transfer Success, otherwise Transfer Fail 1.	
	Transfer Success	Transfer Fail 1
Import Config	Place a USB flash drive that contains only one configuration file stored on the root directory of the stick into the USB port on the front panel of the controller. Press the Enter key to import the configuration file from the stick to the controller. The file name must have an ini extension in its name. The controller will display the progress of the file import process. If the file was successfully imported from the USB disk the controller will display one of the messages below:	
	Import Failure	Indicates that there were problems connecting to or accessing the USB stick.
	Import Success: Any key to reboot	The configuration file import succeeded and will be ready for use after reboot.
	File Open Failed	A config file could not be found on the USB stick or the USB stick file system could not be accessed.
	File Read Failed	The config file is too short (incomplete) or empty.
	Invalid CFG File	The imported file is not a valid config file.
	Invalid Model	The imported config file is not for this controller model.
	Wrong SW Version	The version of the imported config file is not compatible with this controller software version.
	Corrupt CFG File	The imported config file is corrupt. (The checksum failed.)
	Wrong file Size	The size of the imported config file is wrong.

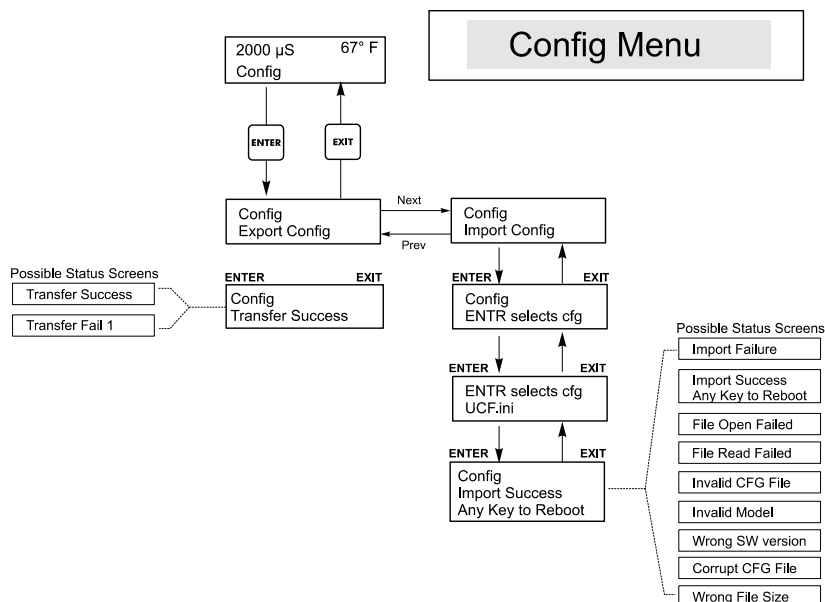

Figure 20 Config Menu

5.14 Upgrade Menu

This menu is available in both WECT400 and WECT410 models. It is used to upgrade the software to a newer version. If a new version of the software is available, an upgrade file will be posted on our web site. Save this file to a USB flash disk drive. It needs to be the only executable (.exe file extension) file stored on the root directory of the stick. Press the Enter key to import the software upgrade file from the stick to the controller.

The controller will display the progress of the file import process. If the file was successfully imported from the USB disk the controller will display Transfer Success. The controller will automatically reboot and come up with the new software installed.

Upgrade	The controller will display the progress of the file import process. If the file was successfully imported from the USB disk the controller will display Transfer Success. The controller will automatically reboot and come up with the new software installed.	
	If the software upgrade fails, you will see one of the following messages:	
	UpgradFileInvalid	The file found on the USB stick is for the wrong product, or is corrupt. Try getting the correct upgrade file and make sure it's the only upgrade file on the stick.
	No Upgrade File	There is no upgrade file stored on the stick, or the file is named incorrectly.
	CorrptUpgradFile	Try getting a new copy of the file.
	Flash Failure	The flash memory on the processor board has a problem. Repair or replace the front panel assembly.

To check that it was successful, turn off power to the controller, then press the Enter key while turning power on. The controller will show the software version, which should match the name of the upgrade file that you used.

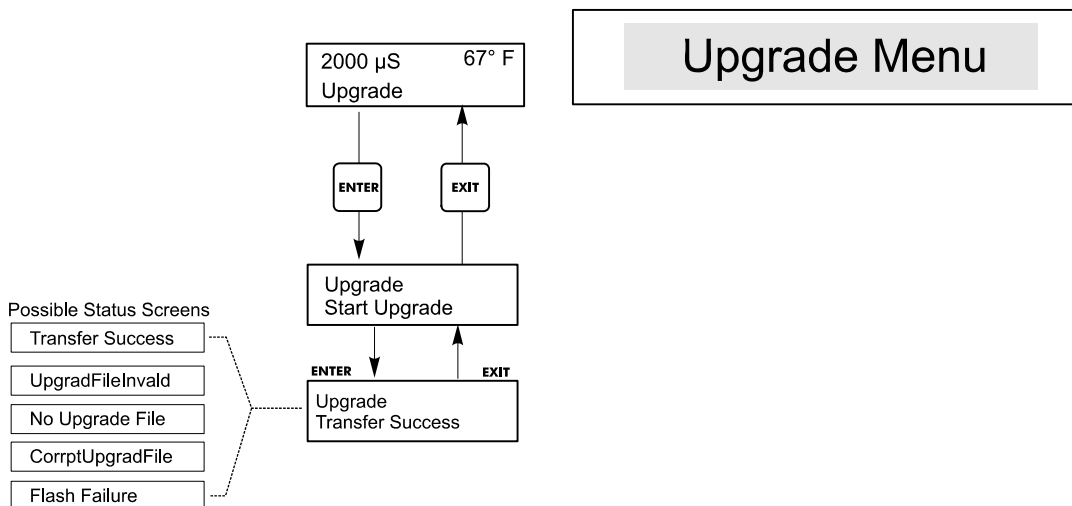

Figure 21 Upgrade Menu

6.0 MAINTENANCE

The WECT controller itself requires very little maintenance. Wipe with a damp cloth. Do not spray down the controller unless the enclosure door is closed and latched.

6.1 Sensor Cleaning

NOTE: The controller must be recalibrated after cleaning the sensor.

Frequency

The sensor should be cleaned periodically. The frequency required will vary by installation. In a new installation, it is recommended that the sensor be cleaned after two weeks of service. To determine how often the sensor must be cleaned, follow the procedure below.

1. Read and record the conductivity.
2. Remove, clean and replace the conductivity sensor.
3. Read conductivity and compare with the reading in step 1 above.

If the variance in readings is greater than 5%, increase the frequency of sensor cleaning. If there is less than 5% change in the reading, the sensor was not dirty and can be cleaned less often.

Cleaning Procedure

An accumulation of dirt or debris on the sensor can affect the accuracy and the thermal time constant. This accumulation should be removed periodically. This can be accomplished by scrubbing with a toothbrush or stiff bottlebrush. Soap or hand cleaner may help. If coated with scale, clean with a dilute (5%) hydrochloric acid solution. Harsh abrasives should be avoided. Rinse the sensor thoroughly before returning to service.

6.2 Replacing the Fuses



CAUTION: Disconnect power to the controller before opening front panel!

Locate the fuses on the circuit board at the back of the controller enclosure. (See figure 3.) Gently remove the old fuse from its retaining clip and discard. Press the new fuse into the clip, secure the front panel of the controller and return power to the unit.

Warning: Use of non-approved fuses can affect product safety approvals. Fuse ratings depend on controller power rating. Specifications are shown below. To insure product safety certifications are maintained, it is recommended that a Walchem fuse be used.

F1 Fuse	Walchem P/N	F2 Fuse	Walchem P/N
5 x 20 mm, 1.0A, 250V	103163	5 x 20 mm, 6A, 250V	102834

7.0 TROUBLESHOOTING



CAUTION: Disconnect power to the controller before opening front panel!

Troubleshooting and repair of a malfunctioning controller should only be attempted by qualified personnel using caution to ensure safety and limit unnecessary further damage. Contact the factory.

7.1 Error Messages

TEMP ERROR

This error condition will stop conductivity control. It indicates that the temperature signal from the conductivity sensor is no longer valid. This prevents controlling based upon a false conductivity reading.

Possible Cause	Correction Action
Green or green/white sensor wire disconnected.	Reconnect.
Faulty sensor.	Replace sensor. Revert to manual temperature compensation by cycling power off and on.

SENSOR ERROR

This error condition will stop conductivity control. It indicates that the conductivity signal from the sensor is no longer valid. This prevents controlling based upon a false conductivity reading.

Possible Cause	Correction Action
Orange or orange/white sensor wire shorted.	Disconnect short.
Faulty sensor.	Replace sensor.
Faulty controller.	Verify via failed self test.

HIGH ALARM

The summary screen will display an H at the right end of the bar graph if the conductivity rises above the high conductivity alarm set point. If your model has an alarm output, the alarm relay will trip. The controller will continue to check the conductivity, and the bleed and/or feed outputs will be active.

Possible Cause	Correction Action
Dirty sensor	Clean sensor (see Sect. 6.1)
Faulty solenoid valve	Repair or replace solenoid valve.
Faulty sensor	Evaluate (see Sect. 7.3). Check Temp display.
Improper wiring of valve or controller	Correct wiring. See Section 3.4.
Conductivity rose over alarm limit while biocide lockout occurred.	Allow normal bleed to occur.
Clogged Y-strainer in bleed line	Clean Y-strainer.
Faulty bleed relay	Replace relay. (Consult factory.)

BLEED TIMEOUT

This error condition will stop conductivity control. It is caused by the bleed output being activated for longer than the programmed Bleed Time Limit.

Possible Cause	Corrective Action
Programmed value too low for normal conditions.	Increase Bleed Time Limit.
Bleed flow rate too low.	Check for clogged strainer. Check for insufficient pressure differential.
Bleed valve not opening.	Check for faulty bleed valve. Check bleed valve wiring. Check controller relay.

LOW ALARM

The summary screen will display an L at the left end of the bar graph and the alarm relay will trip. The controller will continue to check the conductivity and feed inhibitor as programmed.

Possible Cause	Corrective Action
Sensor disconnected	Reconnect. Check cable for continuity.
Sensor dry	Check tee for obstruction. Verify flow. Change location of sensor.
Pre-bleed set too low	Check pre-bleed setting compared to % low.
Solenoid valve stuck open	Repair or replace solenoid valve. (Consult your distributor).

Faulty sensor	Evaluate (see Section 7.3). Replace if necessary.
Improper wiring of sensor	Correct wiring. See Section 3.4.
Faulty bleed relay	Replace relay. (Consult factory.)
NO FLOW	
This error message will appear if the flow/no flow switch closure is opened. The error message will be displayed and the alarm relay will trip. The conductivity is updated but all outputs are deactivated.	
Possible Cause	Corrective Action
No flow	Check recirculating pump, valves, etc.
Faulty flow switch/cable	Check for open circuit. Disconnect flow switch and short the input with a piece of wire. If "no flow" message disappears, then switch or cable may be faulty.
Insufficient pressure drop through sample stream	Check piping.
CAL FAIL	
The controller allows a maximum of $\pm 50\%$ correction to the conductivity reading. This is a cumulative correction factor which means that if at one time the sensor is calibrated by 30%, the next time it is calibrated it will only accept an adjustment of +20% before reporting a Cal Fail.	
The most likely problem is that the sensor needs to be cleaned. Refer to section 6.1.	
TimeErr:SetTime!	
This error message is triggered by corruption of the clock chip. Biocide additions will be locked out until the clock time is reset.	
Possible Cause	Corrective Action
Power spikes, high frequency noise	If this occurs frequently, install a power line filter.

7.2 Conductivity Readout Does Not Change

If the readout is stuck at or near zero:	
Possible Cause	Corrective Action
Dry sensor	Check for flow through system.
Sensor is disconnected.	Check wiring to sensor. Go to self-test menu, as described in section 5.2. If readout changes to 900-1100, the problem is with sensor or connections. See section 7.3 If still at zero, problem is with controller. Consult the factory.
If the readout is stuck at another number:	
Possible Cause	Corrective Action
Dirty or faulty sensor	Evaluate sensor (section 7.3).
Stagnant sample	Check system for proper flow.

7.3 Procedure for Evaluation of Conductivity Sensor

Can be used for troubleshooting low conductivity, high conductivity, conductivity stuck at 0, and/or conductivity stuck at a number other than 0.

Try cleaning the sensor first (refer to Sect. 6.1).

To find out if the sensor or the controller is faulty, step through the Self-Test menu, as described in section 5.2. The display should read $1000 \pm 100 \mu\text{S/cm}$. This indicates that the controller is OK and the problem is in the sensor or its connections. If it does not read $1000 \pm 100 \mu\text{S/cm}$, return the control module for repair.

To check the sensor, check the sensor connections to the terminal strip (refer to Figure 3). Make sure that the correct colors go to the correct terminals, and that the connections are tight. Restore power and see if the conductivity is back to normal. If not, replace the sensor.

8.0 SERVICE POLICY

The WECT series Cooling Tower Conductivity Controller has a 2-year warranty on electronic components and a 1-year warranty on mechanical parts (keypad, terminal strip and relays).

We stock circuit boards for immediate exchange after we have isolated the cause of the problem.

Factory authorized repairs that are received by next-day-air will be returned within 24 hours. Normal priority for returns is two weeks.

Out of warranty repairs or circuit board exchanges are done on a flat fee basis after the warranty is expired.

FIVE BOYNTON ROAD
TEL: 508-429-1110

HOPPING BROOK PARK
FAX: 508-429-7433

HOLLISTON, MA 01746 USA
Web: www.walchem.com